

# LITHIONICS BATTERY®

LITHIUM-ION IRON PHOSPHATE BATTERY SYSTEMS

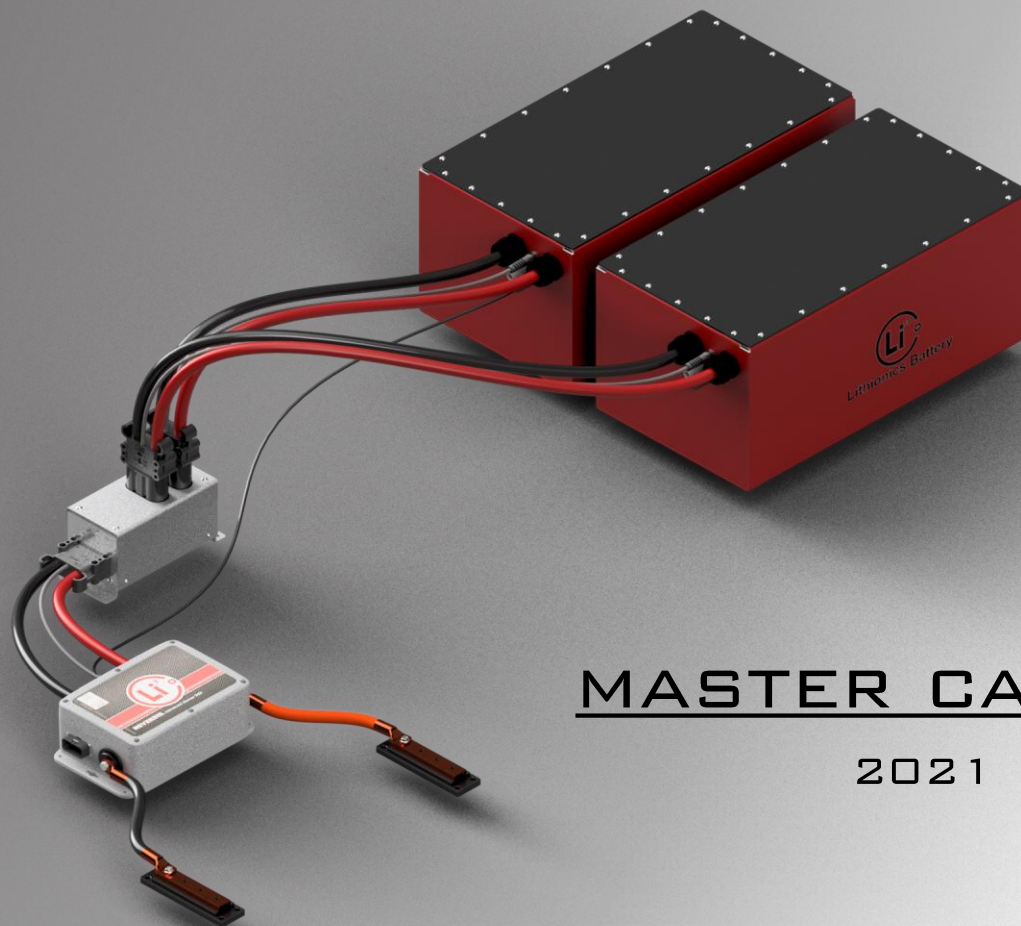

## MASTER CATALOG

2021



The World's Widest Range of Advanced Battery Systems Using NeverDie®, miniBMS® & OptoLoop® Technology



## TABLE OF CONTENTS



**Section 1. Applications**

**Section 2. Safety First: Lithionics Battery® Certifications and Module Safety**

**Section 3. Model Series Defined**

**Section 4. Case Sizes Defined**

**Section 5. Batteries with Internal BMS**

**Section 6. Modules with External BMS**

**Section 7. F Series Batteries**

**Section 8. UL Listed Battery Systems**

**Section 9. NeverDie® Battery Management System (BMS)**

**Section 10. NeverDie® Compact Series Batteries**

**Section 11. Lithionics Battery® Combiner Box and Plug & Play System**

**Section 12. Lithionics Battery® Advantages and Value Proposition**

**Section 13. Lithionics Battery® Custom Build Systems**

# 1. APPLICATIONS

Note: All Photos are of Actual Lithionics Battery® Installations



## ▶ RV House Power & Generator Replacement

Lithionics Battery's safe Lithium-ion Iron Phosphate battery system with NeverDie® Battery Management System technology will revolutionize your dry-camping experience. Reduce or completely eliminate generator run time and minimize charging time with an advanced Lithionics Battery® solution for your RV house power needs. Be sure to pair your lithium battery with approved inverter/charger and solar charge controller equipment to maximize your charge efficiency and battery life.



## ▶ Marine: House Power & Propulsion

NeverDie® lithium battery systems can be used across marine applications, offering a consistent power delivery, lower weight, and longer runtime than tradition lead acid batteries. NeverDie® technology also permits multi-use (hotel & propulsion) from the same battery system. Lithionics Battery® offers battery solutions at 12V, 24V,36V, 48V, 51V 72V, 96V, 144V along with customer specified voltages! Suitable for inverted hotel loads, trolling, electric propulsion, bow thruster and all your electric or hybrid marine needs.



## ▶ Low Speed Electric Vehicles & Automatic Guided Vehicles

Lithionics Battery's Lithium-ion Iron Phosphate battery system provides a reliable and long cycle life energy storage system for your industrial vehicle needs. Our lithium battery designs are optimized for fast re-charge rates, 24/7 use, and zero maintenance. The NeverDie® Battery Management System is also the first to offer bi-directional BMS programming, status and state-of-charge telemetry for remote monitoring and commands in Serial (RS232 or UART), CANBus, or E-TCP/IP data formats.

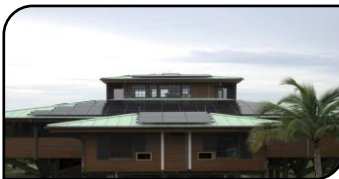

## ▶ Commercial & Residential Energy Storage Including UL Listed Systems

Safe and reliable Lithium-ion Iron Phosphate battery systems can be used to support your off-grid or grid-tied home energy storage needs. Offering 99% recharge efficiency, our lithium battery systems capture the precious energy generated by your solar and wind charging sources to reduce recharge time and generator use. Able to be integrated with popular inverter/charger models, Lithionics Battery® offers a modular parallel system design that lets you easily install, service, or add-on additional capacity in the future.



## ▶ Custom Designed Industrial Batteries

Lithionics Battery® provides experience in offering battery systems from 12V to 512V. With human safety being such an important factor, we offer recommendations for battery configurations including lock-out / tag-out battery disconnect switches, and safe plug-and-play wire harness connection methods. In addition to safety, our NeverDie® Lithium-ion Iron Phosphate battery systems offer the most reliable and consistent power delivery on the market, using the highest quality metals for discharge and recharge efficiency.

## 2. SAFETY FIRST: LITHIONICS BATTERY® CERTIFICATIONS



### UL Standard for Safety Testing Criteria

**UL 157:** Gaskets and Seals

**UL 508:** Industrial Control Equipment

**UL 991:** Tests for Safety-Related Controls  
Employing Solid-State Devices

**UL 1642:** Lithium Batteries

**UL 1998:** Software in Programmable Components

**UL-1973:** 2018 Batteries for Use in Stationary,  
Vehicle Auxiliary Power and Light Electric Rail  
(LER) Applications



### UN DOT for Safety Testing Criteria

**Test T.1:** Altitude simulation: This test simulates air transport under low-pressure conditions.

**Test T.2:** Thermal test: This test assesses cell and battery seal integrity.

**Test T.3:** Vibration: This test simulates vibration during transport.

**Test T.4:** Shock: This test simulates possible impacts during transport.

**Test T.5:** External short circuit: This test simulates an external short circuit.

**Test T.6:** Impact / Crush: These tests simulate mechanical abuse from an impact..

**Test T.7:** Overcharge: This test evaluates the ability of a rechargeable battery to withstand an overcharge.

Testing performed in accordance with the recommendations given forth by the  
UN Transportation of Dangerous Goods Manual of Test and Criteria,  
Sixth Revised Edition, Sections 38.3.4.1 – 38.3.4.5, 38.3.4.7 at



mga research corporation

12790 Main Road  
Akron, New York 14001



## 2. SAFETY FIRST: ENGINEERING WITH MODULE SAFETY



**Battery Safety:** Lithionics Battery® naturally safe chemistry along with an internal shut down curtain technology inside each lithium cell prevents any flame or explosion and thermal runaway events.

**Battery Management System Redundancy:** The NeverDie® Battery Management System is continually monitoring each lithium cell every one second to ensure the safest operation of your system.

**Third Party Validation:** Lithionics Battery's safety technology has been certified by third party accredited facilities such as Underwriter Laboratory for UL Listing and MGA Research Corporation for UN DOT 38.3 compliance.



### Pack Design & Cell Types

- ✓ Organic & Safe Lithium Iron Phosphate Chemistry with ION EXT (Nano-Ceramic Kevlar Shutdown Curtain) Cell Fire Prevention Technology
- ✓ Large format prismatic cell types used for reliable and efficient battery designs

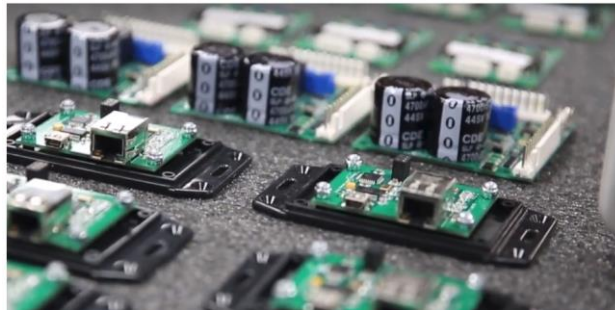

### miniBMS®

- ✓ miniBMS® micro-controllers are installed on every voltage string connection for cell monitoring and balancing
- ✓ miniBMS® monitors cell voltage, temperature, and relays this information to the NeverDie® BMS



### OptoLoop® Circuit

- ✓ BMS uses a reliable communication circuit called OptoLoop® between miniBMS® and the main NeverDie® BMS unit
- ✓ This allows unique flexibility in building large battery systems from multiple modules, connected by the OptoLoop® circuit

### 3. MODEL SERIES DEFINED



As we take advantage of new lithium cell topologies and advances in manufacturing techniques, our battery models are differentiated by the prefix. A brief description of the differences in battery series are defined below. However, all of our battery modules utilizes high quality & safe lithium iron phosphate chemistry with ION EXT (Nano-Ceramic Kevlar Shutdown Curtain) fire prevention technology.

#### **Standard Series**

- High Quality Lithium Iron Phosphate Chemistry
- Reliable, Cost Effective Solution
- Internal Heater Kit Option NOT Available
- Suitable for engine cranking & deep cycle use

#### **GT Series**

- Increased Energy Density
- Increased Charge & Discharge Rates
- Internal Heater Kit Option Available
- Suitable for engine cranking & deep cycle use

#### **GTR Series**

- Utilizes Robotic Manufacturing Techniques
- Allows Modules to be Installed on their Side for Low Profile Height
- Internal Heater Kit Option Available
- Suitable for engine cranking & deep cycle use

#### **GTX Series**

- Utilizes Robotics and Precision Laser-Welding Automation
- Offers Highest Energy Density for Lithium Iron Phosphate
- Internal Heater Kit Option Available
- Suitable for engine cranking & deep cycle use

#### **Comparison of Energy Density**

##### **Standard Series**

12V 450Ah Battery, 5.76kWh



8DR Case (23 x 13 x 13.5 in)

**150lbs**

##### **GT Series**

12V 600Ah Battery, 7.68kWh



8DR Case (23 x 13 x 13.5 in)

**155lbs**

##### **GTR Series**

12V 600Ah Module, 7.68kWh

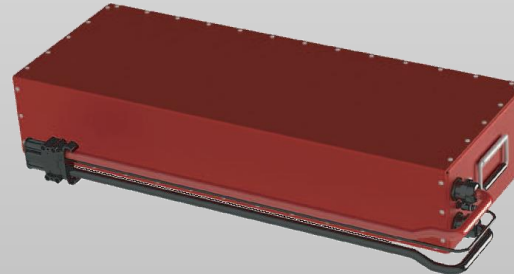

F39 Case (39 x 14.25 x 8 in)

**170lbs**

##### **GTX Series**

12V 555Ah Module, 7.10kWh

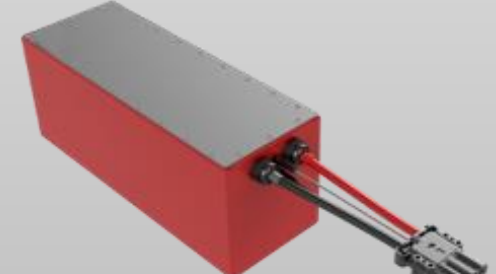

F25 Case (25 x 9 x 10.25 in)

**120lbs**

## 4. CASE SIZES DEFINED (MOLDED TYPE CASES)



When designing our lithium battery models, we do our best to follow the standard BCI group sizes. However, in some cases due to the differences in lithium cell form factors, our case sizes may vary slightly from standard sizes. The chart below summarizes approximate dimensions for our common case sizes. However, we recommend consulting our product data sheets for complete product details and dimensions.

Case	Length	Width	Height
G34EXT	10.56	6.97	8.71
G31-5C	12.50	6.50	8.46
G31EXT	12.94	6.80	10.36
30H	14.93	7.98	13.44
GC2E	22.05	8.05	13.69
5D	24.04	8.02	13.39
5DM	24.04	8.02	13.85
5DR	24.04	8.02	16.54
8D	22.95	13.08	12.48
8DR	23.00	13.00	13.97

Note: Dimensions are in Inches (approximate).  
See Product Data Sheet for Complete Product Details.

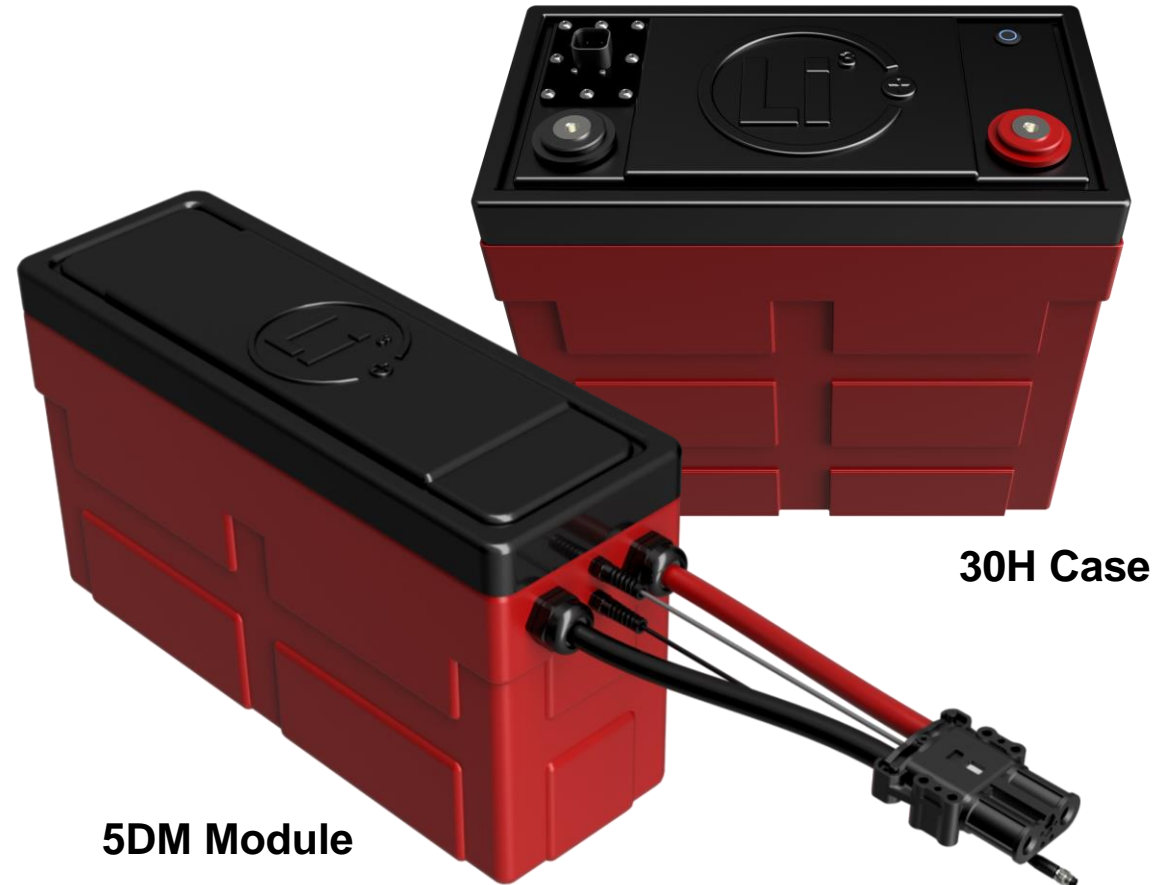

## 5. BATTERIES WITH INTERNAL BMS

(UL LISTED CONTACTOR TYPE NEVERDIE® BMS)



Model	Voltage	Capacity	Weight
GTR12V300A-5DR-CTRL400	12.8 Volts	300 Amp Hours	87 lbs
12V330A-8D-CTRL400	12.8 Volts	330 Amp Hours	115 lbs
GT12V375A-8D-CTRL400	12.8 Volts	375 Amp Hours	110 lbs
12V400A-5DR-CTRL400	12.8 Volts	400 Amp Hours	135 lbs
12V400A-8DR-CTRL400	12.8 Volts	400 Amp Hours	135 lbs
12V450A-8DR-CTRL400	12.8 Volts	450 Amp Hours	150 lbs
GT12V450A-8D-CTRL400	12.8 Volts	450 Amp Hours	130 lbs
GT12V525A-8DR-CTRL400	12.8 Volts	525 Amp Hours	145 lbs
GT12V600A-8DR-CTRL400	12.8 Volts	600 Amp Hours	155 lbs

Model	Voltage	Capacity	Weight
GTR24V150A-5DR-CTRL400	25.6 Volts	150 Amp Hours	87 lbs
24V200A-5DR-CTRL400	25.6 Volts	200 Amp Hours	135 lbs
24V220A-8DR-CTRL400	25.6 Volts	220 Amp Hours	127 lbs
GT24V225A-8D-CTRL400	25.6 Volts	225 Amp Hours	130 lbs
GT24V300A-8DR-CTRL400	25.6 Volts	300 Amp Hours	150 lbs
48V110A-8DR-CTRL200	48.0 Volts	110 Amp Hours	134 lbs
GT48V150A-8DR-CTRL400	48.0 Volts	150 Amp Hours	148 lbs
51V110A-8DR-CTRL200	51.2 Volts	110 Amp Hours	144 lbs
GT51V150A-8DR-CTRL400	51.2 Volts	150 Amp Hours	150 lbs
GT76V75A-8D-CTRL200	76.8 Volts	75 Amp Hours	130 lbs
GT96V75A-8DR-CTRL200	96.0 Volts	75 Amp Hours	150 lbs
GT102V75A-8DR-CTRL200	102.4 Volt	75 Amp Hours	155 lbs

Note: Dimensions are in Inches (approximate). See Product Data Sheet for Complete Product Details.



## 6. MODULES WITH EXTERNAL BMS (MOLDED PLASTIC TYPE CASES)



Model	Voltage	Capacity	Weight
GT12V75A-G34EXT-SBS75X	12.8 Volts	75 Amp Hours	21 lbs
12V110A-G31EXT-DIN	12.8 Volts	110 Amp Hours	32 lbs
GT12V150A-G31EXT-DIN	12.8 Volts	150 Amp Hours	41 lbs
GTR12V150A-30H-DIN	12.8 Volts	150 Amp Hours	43 lbs
12V195A-30H-DIN	12.8 Volts	195 Amp Hours	62 lbs
12V220A-GC2E-DIN	12.8 Volts	220 Amp Hours	62 lbs
GT12V225A-GC2E-DIN	12.8 Volts	225 Amp Hours	65 lbs
GT12V300A-GC2E-DIN	12.8 Volts	300 Amp Hours	75 lbs
GTR12V300A-5D-DIN	12.8 Volts	300 Amp Hours	82 lbs
12V330A-8D-DIN	12.8 Volts	330 Amp Hours	115 lbs
GT12V375A-8D-DIN	12.8 Volts	375 Amp Hours	95 lbs
12V400A-5D-DIN	12.8 Volts	400 Amp Hours	135 lbs
12V400A-8DR-DIN	12.8 Volts	400 Amp Hours	135 lbs
12V450A-8D-DIN	12.8 Volts	450 Amp Hours	150 lbs
GT12V450A-8D-DIN	12.8 Volts	450 Amp Hours	115 lbs
GT12V525A-8D-DIN	12.8 Volts	525 Amp Hours	133 lbs
GT12V600A-8D-DIN	12.8 Volts	600 Amp Hours	150 lbs

Model	Voltage	Capacity	Weight
GT24V75A-G31EXT-DIN	25.6 Volts	75 Amp Hours	41 lbs
24V110A-GC2E-DIN	25.6 Volts	110 Amp Hours	74 lbs
GT24V150A-GC2E-DIN	25.6 Volts	150 Amp Hours	75 lbs
GTR24V150A-5D-DIN	25.6 Volts	150 Amp Hours	82 lbs
24V200A-5D-DIN	25.6 Volts	200 Amp Hours	135 lbs
24V220A-8D-DIN	25.6 Volts	220 Amp Hours	127 lbs
GT24V225A-8D-DIN	25.6 Volts	225 Amp Hours	125 lbs
GT24V300A-8D-DIN	25.6 Volts	300 Amp Hours	145 lbs
GT48V75A-GC2E-DIN	48.0 Volts	75 Amp Hours	80 lbs
48V110A-8D-DIN	48.0 Volts	110 Amp Hours	134 lbs
GT48V150A-8D-DIN	48.0 Volts	150 Amp Hours	148 lbs
GT51V75A-GC2E-DIN	51.2 Volts	75 Amp Hours	83 lbs
51V110A-8D-DIN	51.2 Volts	110 Amp Hours	144 lbs
GT51V150A-8D-DIN	51.2 Volts	150 Amp Hours	150 lbs
GT76V75A-8D-DIN	76.8 Volts	75 Amp Hours	125 lbs
GT96V75A-8D-DIN	96.0 Volts	75 Amp Hours	145 lbs
GT102V75A-8D-DIN	102.4 Volt	75 Amp Hours	150 lbs

Note: Dimensions are in Inches (approximate). See Product Data Sheet for Complete Product Details.

## 7. F SERIES BATTERIES ( AIRCRAFT GRADE ALUMINUM ALLOY, POWDER COATED, TYPE CASES )



### Custom F-Series Aluminum Case Options:

Case	Length	Width	Height	Modules (Requires External BMS)
F1508	15.00	8.00	13.12	GT12V150A, 12V195A, GTX12V210A, GT24V75A, GTX24V105A, GTX12V275A
F1915	19.00	15.00	11.12	GT12V375A, GT12V450A, GT12V525A, GT48V150A
F2413	24.00	13.00	11.12	GTX12V420A-UL, GT12V450A-UL, GTX12V525A-UL, GT12V600A-UL, GTX12V630A-UL, GT24V300A-UL, GTX24V315A-UL, GT48V150A-UL, GTX51V105A-UL, GT51V150A-UL
F2509	25.00	9.00	10.12	GTX12V555A, GTX24V275A
F3717	37.40	17.40	14.00	GT51V300A
F3914	39.00	14.12	8.00	GTR12V450A, GTR12V600A
F4113	41.00	13.37	12.85	GTX12V1050A-UL, GTX12V1155A-UL, GTX12V1260A, GTX24V630A, GTX51V315A

Note: Dimensions are in Inches (approximate). See Product Data Sheet for Complete Product Details.

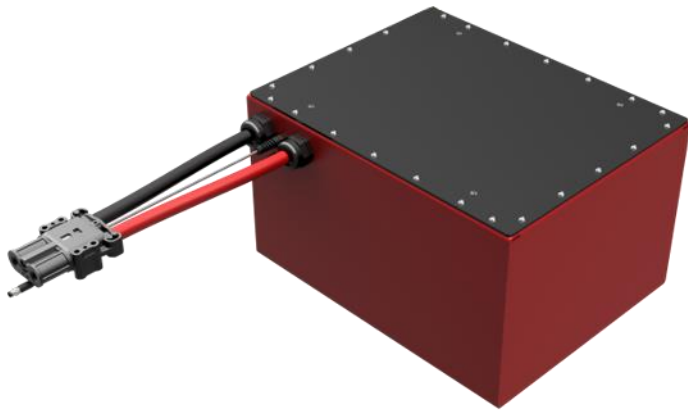

### F Series Features

- Custom Manufactured Sealed Aluminum Enclosures (Meets UL 157)
- Allows for Variety of Installation Locations & Options
- Includes Pressure Balancing Valve
- IP 67 Environmental Rating
- UL Compliant & Crush Test Rated (22,000lbs)



## 8. UL 1973 LISTED BATTERY SYSTEMS

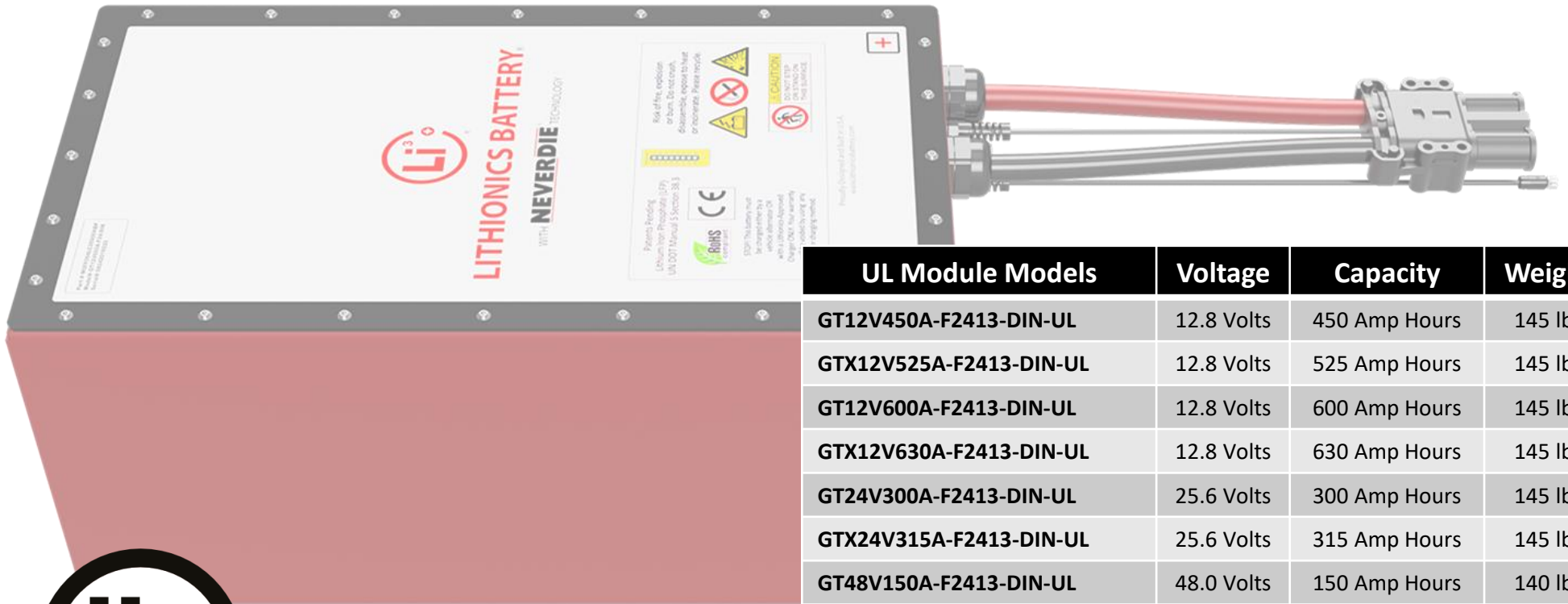

UL Listed to UL1973, 991, 1998, 157, 1642, 508

UL Module Models	Voltage	Capacity	Weight
GT12V450A-F2413-DIN-UL	12.8 Volts	450 Amp Hours	145 lbs
GTX12V525A-F2413-DIN-UL	12.8 Volts	525 Amp Hours	145 lbs
GT12V600A-F2413-DIN-UL	12.8 Volts	600 Amp Hours	145 lbs
GTX12V630A-F2413-DIN-UL	12.8 Volts	630 Amp Hours	145 lbs
GT24V300A-F2413-DIN-UL	25.6 Volts	300 Amp Hours	145 lbs
GTX24V315A-F2413-DIN-UL	25.6 Volts	315 Amp Hours	145 lbs
GT48V150A-F2413-DIN-UL	48.0 Volts	150 Amp Hours	140 lbs
GTX51V105A-F2413-DIN-UL	51.2 Volts	105 Amp Hours	145 lbs
GT51V150A-F2413-DIN-UL	51.2 Volts	150 Amp Hours	145 lbs
Module Case Dimensions	Length	Width	Height
F2413	24.00	13.00	11.12

# 9. NEVERDIE® BATTERY MANAGEMENT SYSTEM (BMS)

(UL 991, 1998, 508 LISTED)



Lithionics Battery's NeverDie® Battery Management System is a proprietary design featuring UL tested protective safety features, as well as state-of-health (status & fault codes), and state-of-charge monitoring. Our patent-pending BMS utilizes custom microprocessors and in-house controlled firmware that enables the customization of the BMS to perform as a Programmable Logic Controller (PLC.) The NeverDie® Battery Management System is standard on all Lithionics Battery® systems to ensure your lithium batteries are operated within their rated specifications. This increases the lifespan of your battery system and protects your valuable investment. Unlike many competitors, Lithionics Battery® uses a military grade proprietary contactor (UL508 tested to 6,000 hot-switching cycles) for BMS on/off switching. This allows for continuous current ratings of up to 400A to match the high performance of your lithium battery module.

**Internal NeverDie® BMS**  
200A or 400A Rating



**Standard NeverDie® BMS**  
12V to 51V 400A Rating



**Advanced NeverDie® BMS**  
12V to 96V 400A Rating



**High Voltage NeverDie® BMS**  
102V to 512V 400A Rating



Available Features:

- ▶ Ampseal I/O Connector
- ▶ Round SOC Display\*
- ▶ Bluetooth® Transmitter
- ▶ Status & Fault Code Reader

\*Available on Advanced Series Only

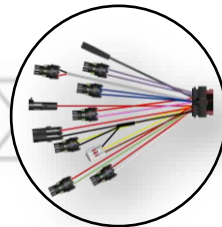



# 9. NEVERDIE® BATTERY MANAGEMENT SYSTEM CONT.



NeverDie® BMS Features	Standard Series (12V to 51V)	Advanced Series (12V to 96V)	Dual Channel Series (12V to 51V)	High Voltage Series (102V to 512V)
OptoLoop® Cell Monitoring	✓	✓	✓	✓
MiniBMS® Cell Balancing	✓	✓	✓	✓
NeverDie Reserve (Reset/Power Switch)	✓	✓	✓	✓
Low-Voltage Cutoff Protection (Over-Discharge)	✓	✓	✓	✓
High-Voltage Cutoff Protection (Over-Charge)	✓	✓	✓	✓
Short Circuit Protection	✓	✓	✓	✓
Current Direction Based Temperature Intervention Sensor	✓	✓	✓	✓
UL Approved Fully Redundant Protective Safety Circuits	✓	✓	✓	✓
Military Grade Latching Contactor with Aux Contact Monitoring	✓	✓	✓	✓
Coulomb Based State-of-Charge Meter	✓	✓	✓	✓
Programmable NeverDie Reserve & AGSR	✓	✓	✓	✓
State of Health Monitoring (Status & Fault Codes)	✓	✓	✓	✓
BMS Data Telemetry – CANBus	✓	✓	✓	✓
BMS Data Telemetry – Bluetooth or Serial Port	Bluetooth Only	Order Option	Order Option	Order Option
BMS Data Telemetry – Ethernet TCP/IP		Optional	Optional	Optional
Dual Channel (Independent Charge/Discharge Channels)			✓	
Redundant Coil-Driven Contactor		Optional		
Internal Pre-Charge Circuit (Programmable)		Optional for 48V to 96V		✓
Ampseal I/O Features	Standard (8-Pin)	Advanced (23-Pin)	Advanced (23-Pin)2	Advanced (23-Pin)3
Alternator Field Control Circuit (FCC)	✓	✓	✓	✓
CANBus (Supports RV-C BMS Data & NCC Charger Series)	✓	✓	✓	✓
Remote Power Switch	✓	✓	✓	✓
Serial UART BMS Data Telemetry (Alternate: Serial RS232)		✓	✓	✓
Automatic Generator Start/Restart (AGSR)		✓	✓	✓
External Pre-Charge Circuit Control (Alternate: Heater Power)		✓	✓	✓
BMS Auxiliary Power Input (AC Sense)		✓	✓	✓
High Voltage Charger Interlock		✓	✓	✓
Tri-Color LED Pod (Alternate: LED for Remote Reset Switch)		✓	✓	✓
Alarm Circuit		✓	✓	✓
Battery Percent (0-5V Signal)		✓	✓	✓
Emergency Stop Input (E-Stop Circuit)		✓	✓	✓

# 10. NEVERDIE® COMPACT SERIES BATTERIES

Compact Series using our Economy-Version 100 Amp Rated BMS (CS100) & 200 Amp Rated BMS (CS200)



## 100 Amp Rated BMS Models

Model	Voltage	Capacity	Weight
12V125A-G31-CS100	12.8 Volts	125 Amp Hours	34 lbs
12V195A-30H-CS100	12.8 Volts	195 Amp Hours	60 lbs

## 200 Amp Rated BMS Models

Model	Voltage	Capacity	Weight
GTX12V210A-E-CS200*	12.8 Volts	210 Amp Hours	48 lbs
GTX12V315A-E-CS200*	12.8 Volts	315 Amp Hours	68 lbs
GTX12V420A-E-CS200*	12.8 Volts	420 Amp Hours	88 lbs

\*E-Series case sizes coming, product release April 2020.



## Internal NeverDie® Compact Series Features

- miniBMS® Cell/Module Sensors and Microprocessors with Automatic Cell Balancing
- 100A or 200A Continuous Discharge Current Rating
- Over-Charge, Over-Discharge and Short-Circuit Protection (LVC, HVC, SCC)
- Pushbutton Storage Operation
- NeverDie® Power Reserve (Spare Fuel) for Hotel Loads and Worry-Free Power for Engine Cranking
- Optional Bluetooth®: Monitor Battery Voltage, State-of-Charge, Temperature, Current & Status Code from your mobile device.



LITHIONICS BATTERY® NOW WITH BLUETOOTH® TELEMETRY



Bluetooth® Telemetry Available for NeverDie® Compact Series & NeverDie® Advanced Series Battery Management Systems.

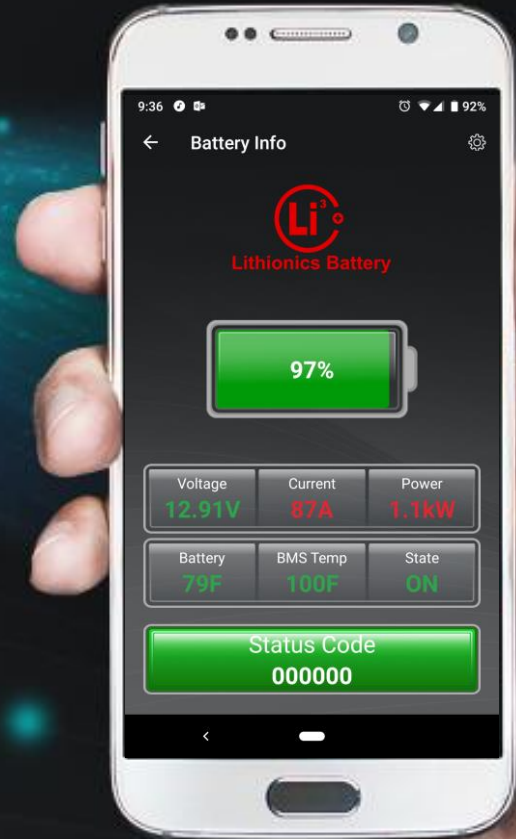

**Li<sup>3+</sup> Lithionics Battery® Monitor**



# 1.1. LITHIONICS BATTERY® PLUG & PLAY SYSTEM

Lithionics Battery® Modular Expansion via the Parallel Combiner Box



2-Port Combiner Box used for Expansion

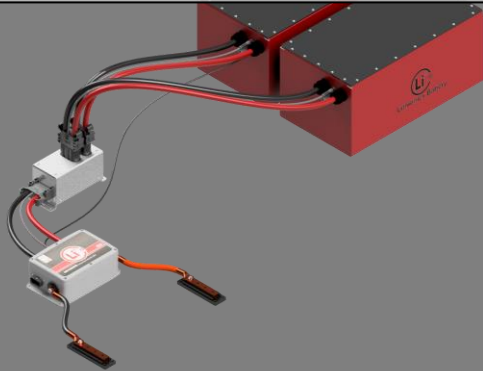

4-Port Combiner Box used for Expansion

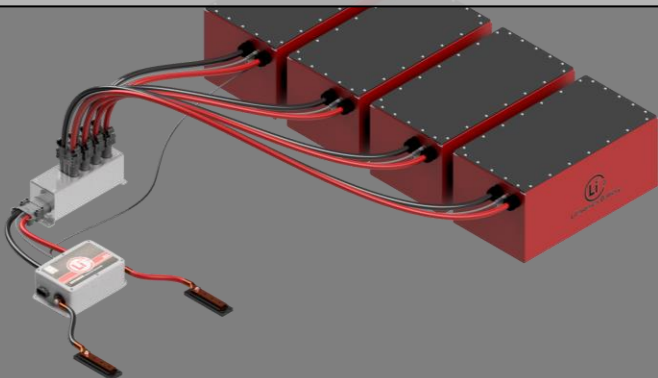

6-Port Combiner Box used for Expansion

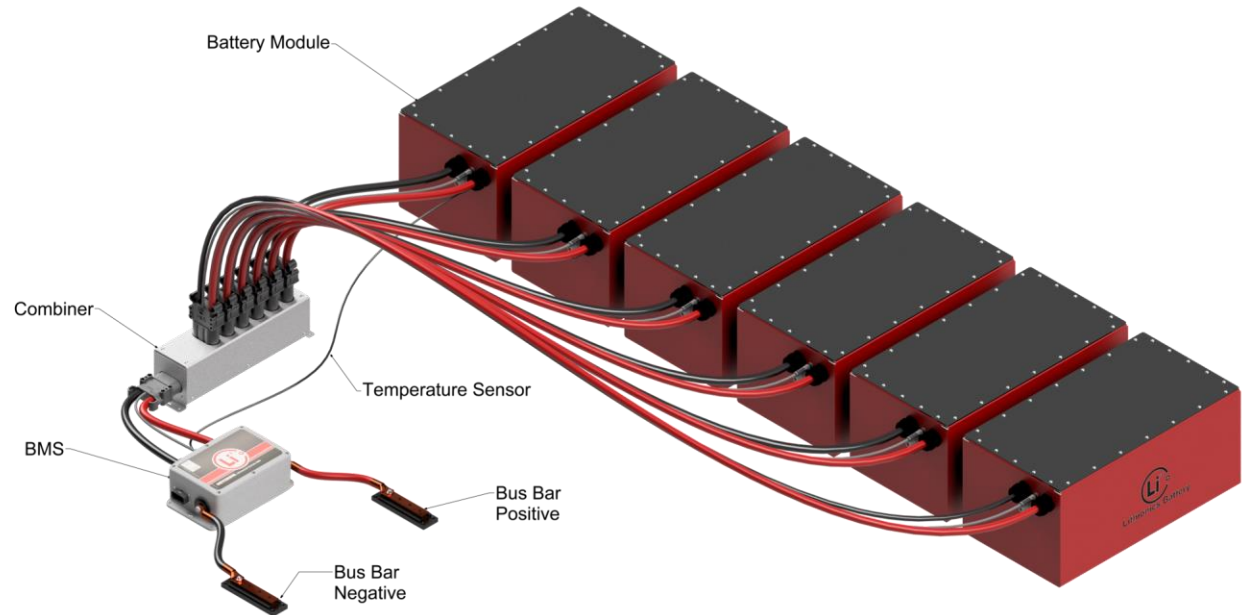

Click here for more information on the [Plug & Play Combiner Box](#), or visit the Products page of our website.



## 1.1. PLUG & PLAY COMBINER BOX OPTIONS



The Plug & Play system features our parallel combiner box for parallel connections. The Plug & Play connector system reduces the risk of short circuit or mis-wiring during installation and allows you to quickly connect or disconnect your system in minutes. Lithionics Battery® manufactures our wire harness and combiner box systems in-house to the recommended crimp and connection standards and fully tests all connections alongside your battery system for quality assurance.

▶ **2 Port Combiner Box**



▶ **4 Port Combiner Box**

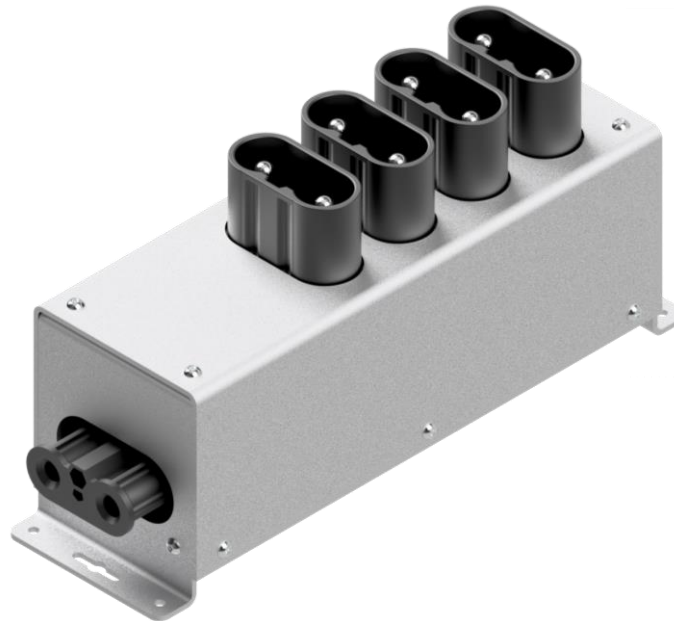

▶ **6 Port Combiner Box**

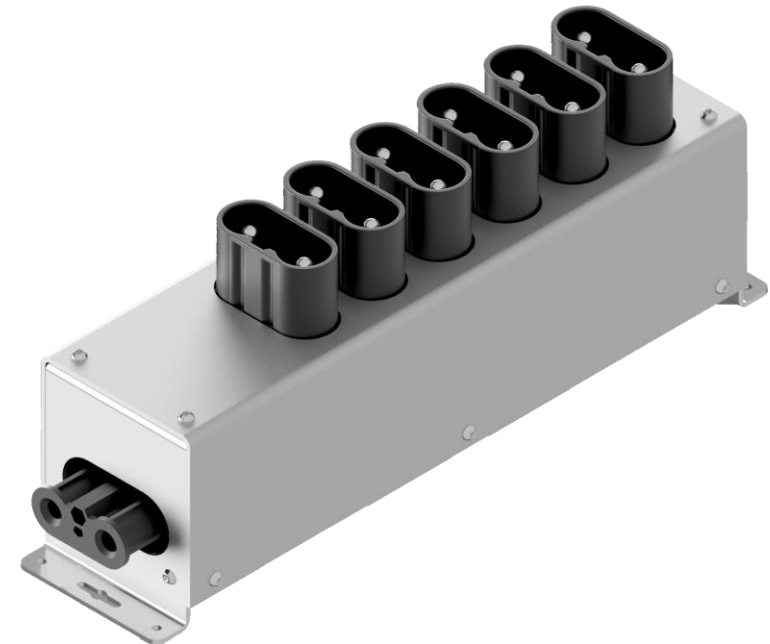

**Up to 400 Amps Continuous**

Note: Jumper DIN Connector Required for Unused Ports.

## 1 2. LITHIONICS BATTERY® ADVANTAGES



### Lithionics Battery® Advantages:

- ✓ **Safety a Must:**
  - High Quality & Safe Lithium Iron Phosphate Chemistry
  - ION EXT (Nano-Ceramic Kevlar Shutdown Curtain) Cell Fire Prevention Technology
  - 3rd Party UL & UN DOT Safety Testing
- ✓ **Dedicated to Quality:**
  - Cell Testing & Impedance Matching
  - FLIR Thermal Imaging for Quality Assurance
  - Documented 100% System Load & Capacity Testing
- ✓ **Proprietary NeverDie® Battery Management System:**
  - Pushbutton Battery Power/Storage Switch
  - Protective UL Safety Features
  - State-of-Charge Telemetry
  - State-of-Health Monitoring (Status & Fault Codes)
- ✓ **Our Team:**
  - Dedicated Engineering, Manufacturing, & Support Staff.
  - On-site HazMat Pick-Up Available for Service & Repair (US 48 States)

### Low Cost Alternatives:

- × **Safety at a Cost:**
  - Low Priced Batteries Sacrifice Safety Features in Favor of Cost Reductions
  - Lower Cost Inorganic Lithium Chemistries can be Volatile with Risk of Fire or Explosion
- × **Lack of Verifiable Testing:**
  - Lack of Safety & Quality Testing Certificates
- × **No Intelligent Controls:**
  - Look for Buttons: No Power Switch for Battery Control or Storage
  - Unable to Monitor Battery State-of-Charge or Health
- × **Disreputable Service:**
  - No Programs for Returning Lithium Batteries (HazMat Packages)
  - Lack of Warranty or Repair Service

## 1 2. LITHIONICS BATTERY® VALUE PROPOSITION



Our NeverDie® advanced battery and energy systems are designed to offer real and measurable savings when replacing alternative battery chemistries. These cost savings will be proven in various forms such as...

- ✓ **Weight** savings that permit other systems to be cost-reduced.
- ✓ **98% Solar Charge** Efficiency
- ✓ Electricity savings resulting from superior **re-charging** efficiencies.
- ✓ Increased life expectancy in host devices resulting from superior **voltage stability**.
- ✓ **Battery life** expectancies that are at least double the technology we replace.
- ✓ Environmentally friendly and **ROHS-compliant** energy solutions.

# Lithionics Battery

# 13. LITHIONICS BATTERY® CUSTOM BUILD SYSTEMS



Lithionics Battery® is staffed with actual application and design engineers with years of industry experience. If a standard battery solution does not meet your energy or size requirements, our staff is available to assist you throughout the design and production process to offer a custom battery solution to meet your needs.

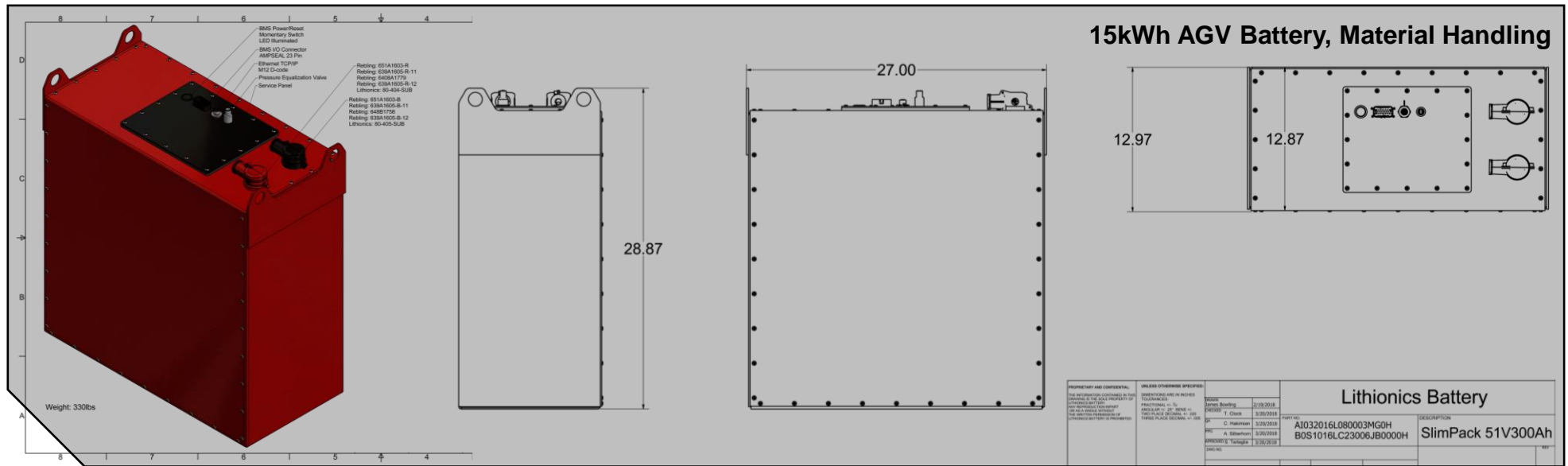

Custom Applications | Lithionics Battery® has engineering capabilities to design custom battery systems to go along with your application power requirements. Lithionics Battery® also has experience in a variety of markets and can adapt quickly to offer battery and battery connections solutions. Please contact Lithionics Battery® to discuss your battery needs.

## Find your Lithium Battery Solution

Unlock the power of energy independence wherever you are, no matter what you are doing! To learn more about lithium replacement systems for your application, contact Lithionics Battery®.