



**2 Inputs, 2 Outputs:**  
**Total, flexible load control**

Technical Description

InPower’s ReFlex control module brings a new level of flexibility and customizability to vehicle load control. No more bulky, confusing relay banks with this module! Fully programmable, the RX-0202 gives you two inputs and two outputs to control anything you need.

The unit is housed in a sturdy anodized aluminum case and furnished with a single eight pin connector. The connector has two output pins, one ground pin, two +12V power input pin, one programming pin and two system input pins.

The inputs can be defined as pull up or pull down. The outputs can be independent or in parallel and each can supply up to 15 amps. The programming pin allows the program to be replaced or adjusted as necessary to ensure it always meets your needs.

Please call InPower, LLC at 740-548-0965 to discuss your control needs today!

Key Features

- Two Inputs, Two outputs, 15 amps each
- Solid-state, connectorized load control
- Compact size
- Eliminates need for bulky relay banks
- Durable Metal Case
- Custom Programs Available
- Easy to Reprogram

**RX-0202 System Diagram**

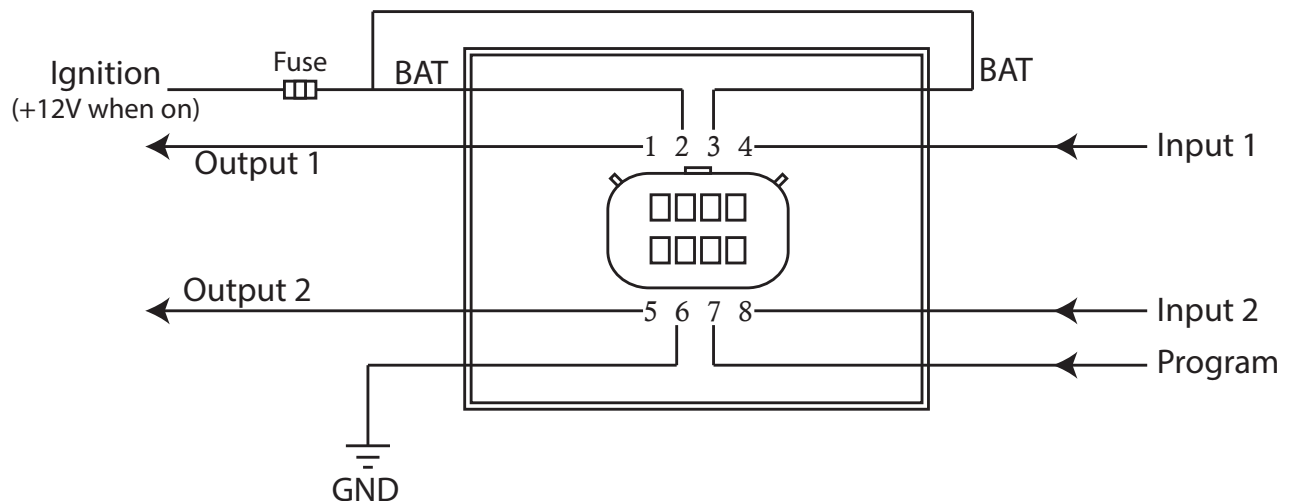

### Specifications

Power Input:	+12V ; this may be wired to a fused ignition source
Signal Inputs:	Definable as responsive to ground or positive
Power Outputs:	Together can supply up to 15 amps each
Dimensions:	2.25 x 1.75 x 1.25 inches
Case Material:	Anodized Aluminum
Operating Temperature:	-40°C to 85°C

### Connector

The mating connector to the one found on the ReFlex module is an 8 position Molex MX150 connector, part number 33472-4801. Please refer to Molex's MX150 Application Guide and other documentation for information on proper assembly and wire insertion.

### Mechanical Drawing

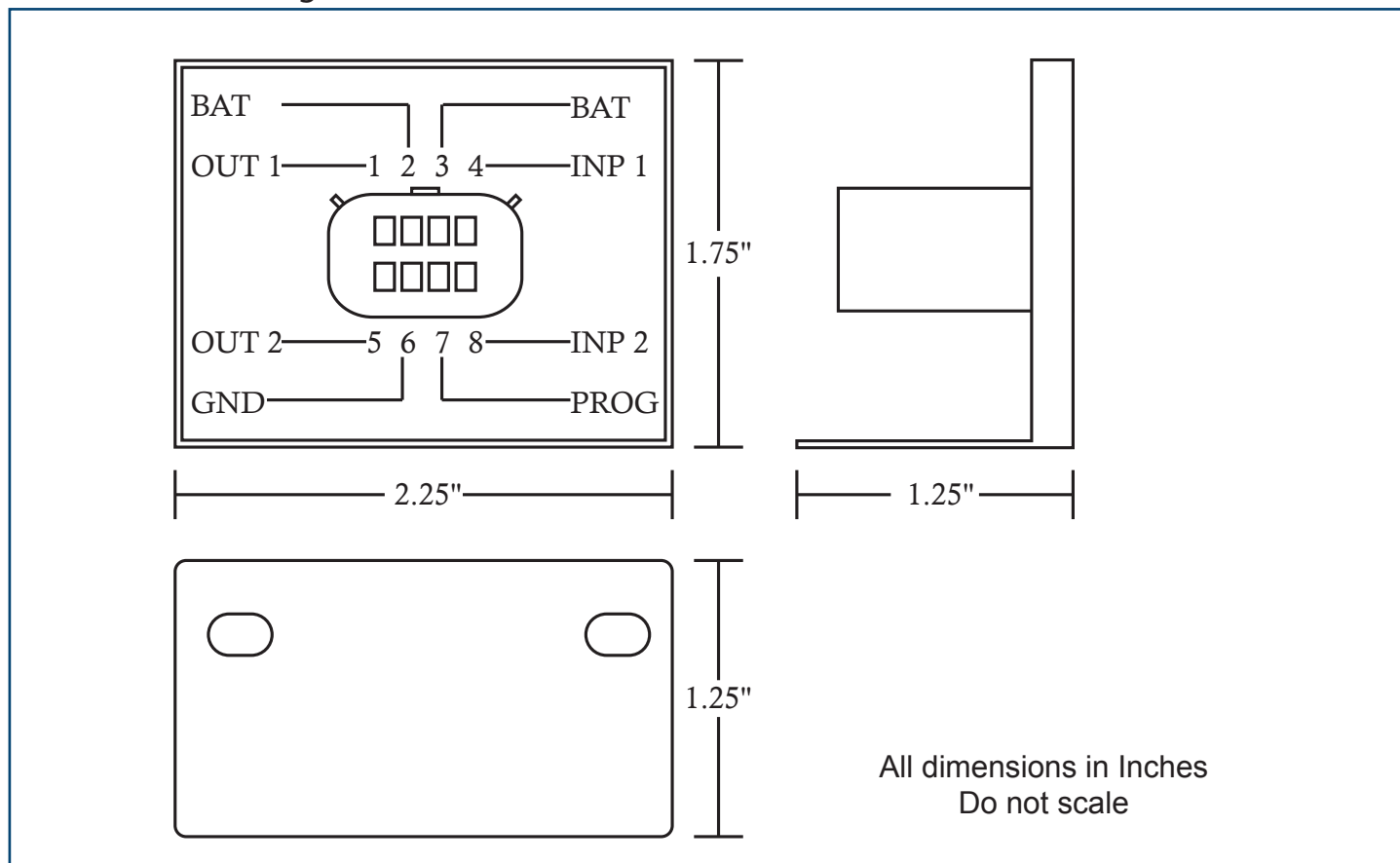



**3 Inputs, 2 Outputs - Total, flexible load control**

**Technical Description**

InPower’s ReFlex control module brings a new level of flexibility and customizability to vehicle load control. No more bulky, confusing relay banks with this module. Fully programmable, the RX-0302 gives you three inputs and two outputs to control anything you need.

The unit is housed in a sturdy anodized aluminum case and furnished with a single eight pin connector. The connector has two output pins, one ground pin, one +12V power input pin, one programming pin and three system input pins.

The inputs can be defined as pull up or pull down. The outputs can be independent or in parallel, but their total supplied amperage cannot exceed 15 amps. The programming pin allows the program to be replaced or adjusted as necessary to ensure it always meets your needs.

Please call InPower, LLC at 740-548-0965 to discuss your control needs today!

**Key Features**

- Three Inputs, Two outputs
- Solid-state, connectorized load control
- Compact size
- Eliminates need for bulky relay banks
- Durable Metal Case
- Custom Programs Available
- Easy to reprogram

**RX-0302 System Diagram**

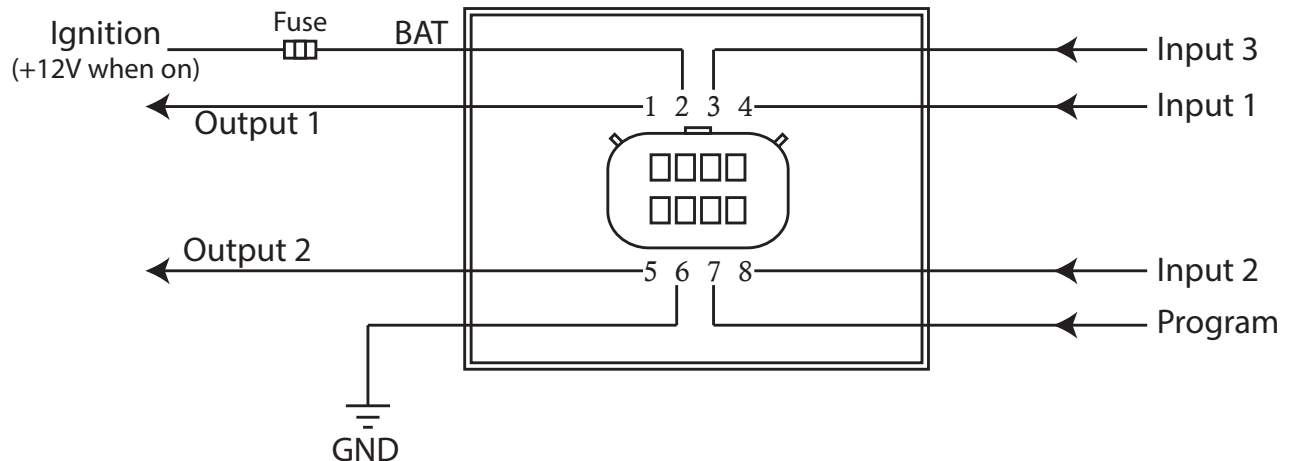

### Specifications

Power Input:	+12V ; this may be wired to a fused ignition source
Signal Inputs:	Definable as responsive to ground or positive
Power Outputs:	Together can supply up to 15 amps total
Dimensions:	2.25 x 1.75 x 1.25 inches
Case Material:	Anodized Aluminum
Operating Temperature:	-40°C to 85°C

### Connector

The mating connector to the one found on the ReFlex module is an 8 position Molex MX150 connector, part number 33472-0801. Please refer to Molex's MX150 Application Guide and other documentation for information on proper assembly and wire insertion.

### Mechanical Drawing

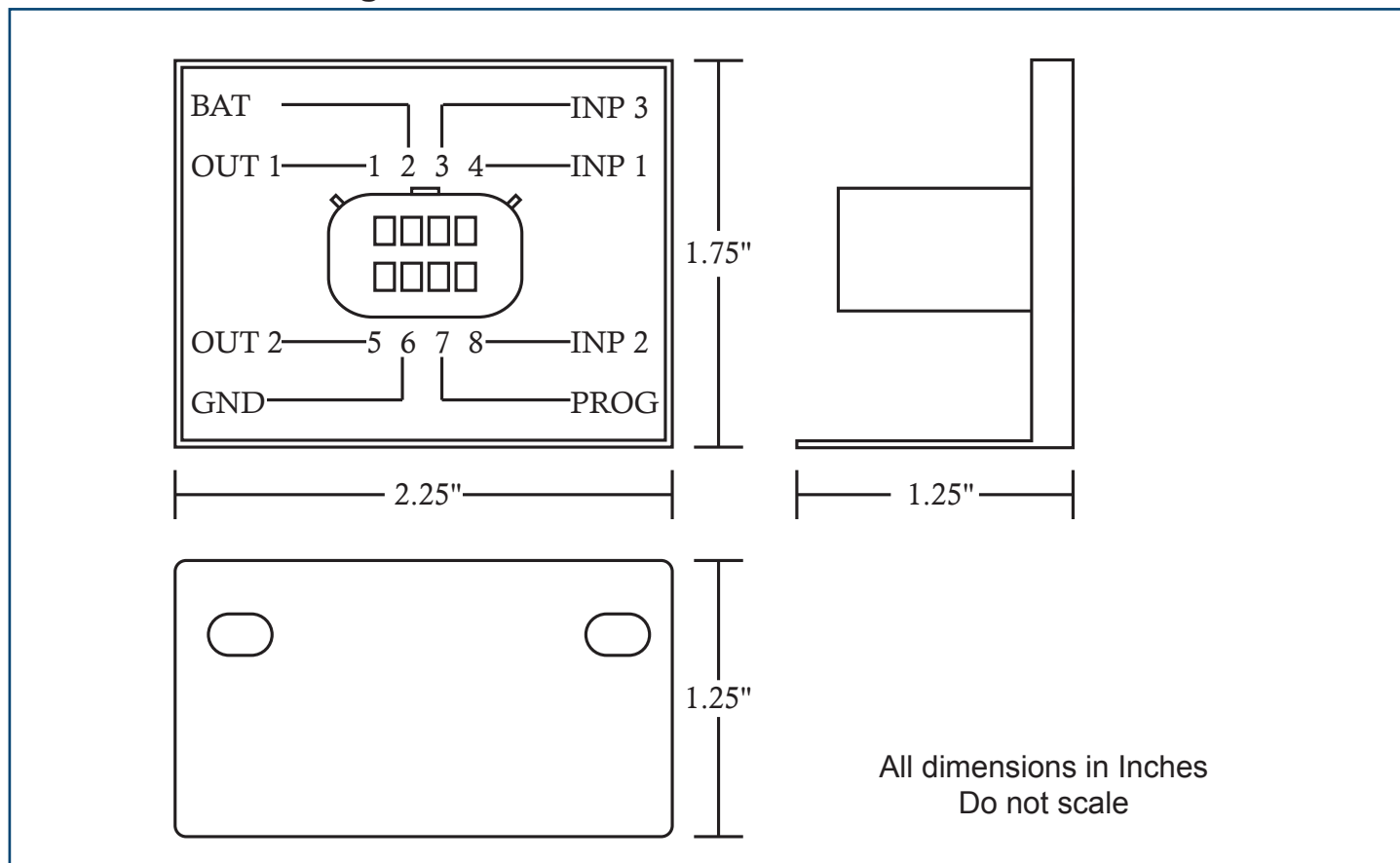

# VCMS2-GM1 VCMS2-GM1-CTRL1

## 8 Input/ 8 Ground Output Module With Molex Connectors



### Technical Description

The Model VCMS2-GM1 Ground Output Module is a component of the InPower's second generation Vehicle Control Module System (VCMS2), a modular, programmable switch panel system used for controlling 12 volt auxiliary devices on vehicles. The system can be configured for a wide range of applications controlling devices such as lights, relays, vehicle interfaces, and other devices needing a maximum 1.0 Amps sink. All power modules and switch panels connect via an 8 pin Molex-150 sealed connector and may be daisy-chained to accommodate extra modules and panels.

The power module has eight inputs and eight outputs, connected through a 20 pin Molex-150 sealed connector. The outputs are rated at 1.0 amps sinking each from a 12 V Source. The digital inputs monitor external conditions, such as what gear the transmission is in or if the ignition switch is on, and can be programmed to respond to either ground or +12 V.

### Key Features

- Small Size, L-bracket mounting
- Eight Ground Out 1.0 Amp Sinking Outputs
- Eight Digital Inputs
- Modular/Expandable Design
- Remote Operation
- Programmable Control Logic Functions

The GM1 is used in conjunction with VCMS2 Switch Module(s) and Power Modules in different configurations of MOD1 through MOD6 where up to 6 Ground Out or PM1 Power Modules are needed in a system. In these cases the application program is in the main Switch Module.

The GM1-CTRL1 is used in VCMS2 systems that have no switch module(s) (Standalone system). This may be a single GM1-CTRL1 by itself, or with up to 5 other networked GM1s or PM1s (GM1-MOD2 through GM1-MOD6). In this case the application program is located in this VCMS2-GM1-CTRL1.

### Related Products

- VCMS2-SM-4 thru SM-12 Switch Modules
- VCMS2-PM1 and CNTRL-1 Power Out Modules

Modules may be ordered as VCMS2-GM1-MOD1, VCMS2-GM1-MOD2, VCMS2-GM1-MOD3, through MOD6 or as a VCMS2-GM1-CTRL1.

### Mechanical Drawing

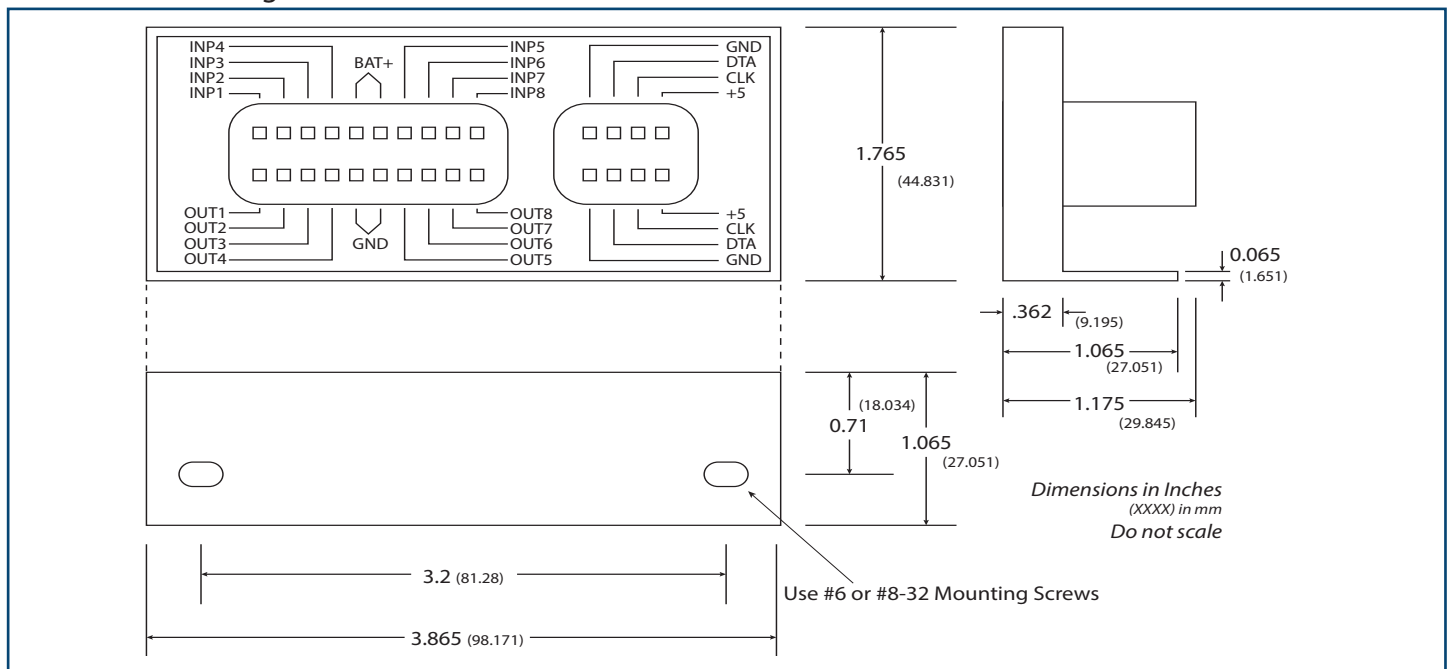

# VCMS2-GM1

## VCMS2-GM1-CTRL1

# 8 Input/ 8 Ground Output Module With Molex Connectors

### Specifications

Dimensions:	Mounting Surface: 1.065 inches by 3.865 inches. 1.765 inches tall.
Case Material:	Anodized aluminum
Mounting:	Two #6-32 or #8-32 Mounting Screws through L bracket to a flat surface.
Mating Connectors:	One 20 pin A key Molex-150 (part # 33472-2001): inputs, outputs and power One 8 pin A key Molex 150 (part # 33472-0806): ground and data between modules
Outputs:	Eight Low-side drivers rated for Ground Outputs at 1.0 Amps Sink
Inputs:	Eight programmable to pull up for ground true actuation or to pull down for +12 volt true actuation
Orderable Configurations:	VCMS2-GM1-CTRL1 (for Standalone systems (application)), VCMS2-GM1-MOD1, VCMS2-GM1-MOD2, VCMS2-GM1-MOD3, VCMS2-GM1-MOD4, VCMS2-GM1-MOD5, or VCMS2-GM1-MOD6.

Related Products: VCMS2-SM4, VCMS2-SM6, VCMS2-SM8, VCMS2-SM10, VCMS2-SM12 switch modules, and VCMS2-PM1-CTRL1, VCMS2-PM1-MOD1, VCMS2-PM1-MOD2, VCMS2-PM1-MOD3, VCMS2-PM1-MOD4, VCMS2-PM1-MOD5, and VCMS2-PM1-MOD6.

### System Diagram

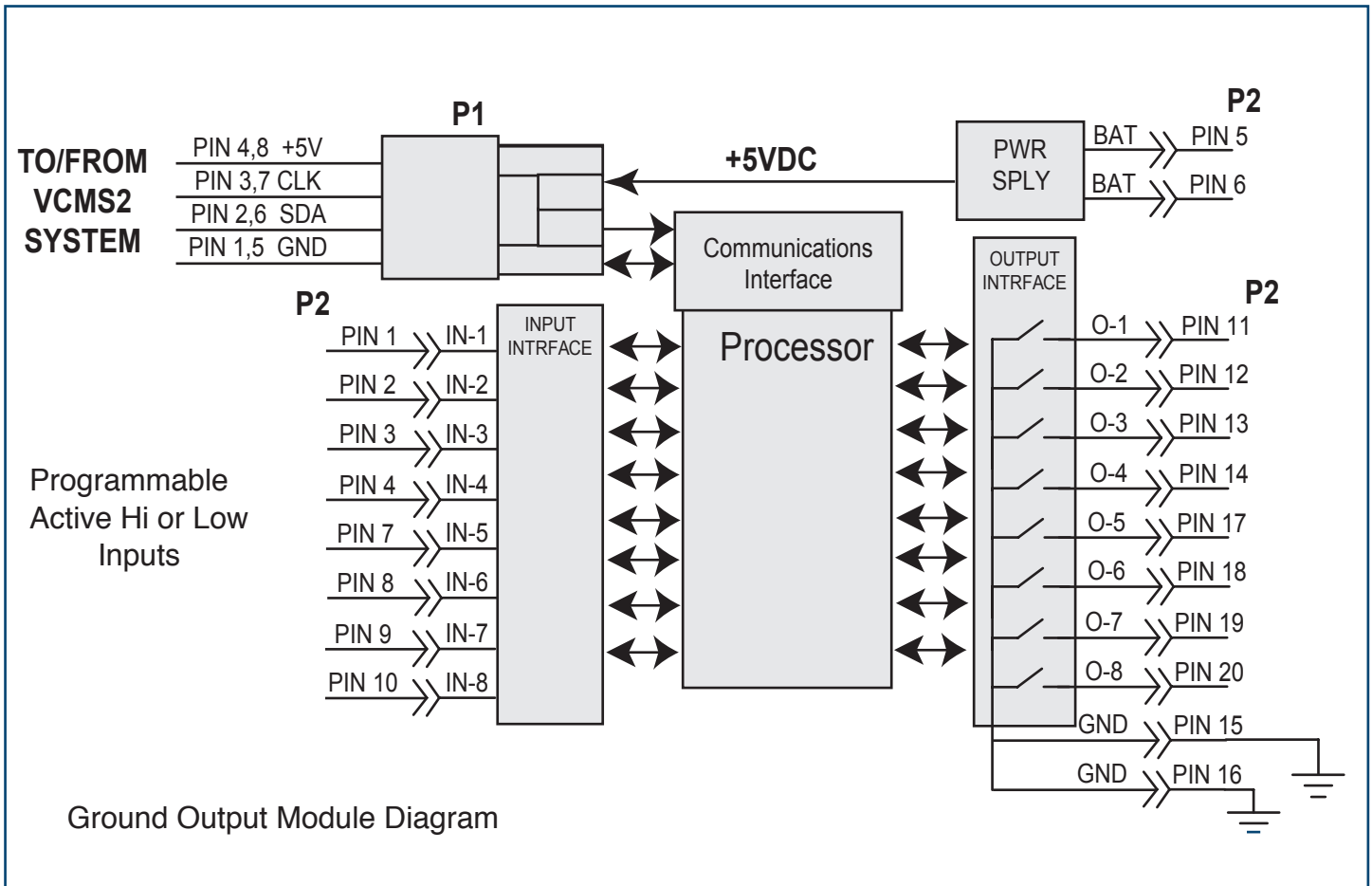

# VCMS2-PM1 VCMS2-PM1-CTRL1

8 Input/ 8 Output Power Module  
With Molex Connectors



## Technical Description

The Model VCMS2-PM1 Power Module is a component of the InPower's second generation Vehicle Control Module System (VCMS2), a modular, programmable switch panel system used for controlling 12 volt auxiliary devices on vehicles. The system can be configured for a wide range of applications controlling devices such as lights, beacons, fans, compressors, and other 12 V devices.

All power modules and switch panels connect via an 8 pin Molex-150 sealed connector and may be daisy-chained to accommodate extra modules and panels.

The power module has eight inputs and eight outputs, connected through a 20 pin Molex-150 sealed connector. The outputs are 12 V power rated at 15 amps each and include over current and automatic short circuit fault shutdown protection. The digital inputs monitor external conditions, such as what gear the transmission is in or if the ignition switch is on, and can be programmed to respond to either ground or +12 V TRUE.

The PM1 is used in conjunction with VCMS2 Switch or GM1 Module(s) in different configurations of either GM1 or PM1 MOD1 through MOD6 where up to 6 Modules are needed in a system. In these cases the application program is in the main Switch Module.

The PM1-CTRL1 is used in VCMS2 systems that have no switch module(s) (Standalone system). This may be a single PM1-CTRL1 by itself, or with up to 5 other networked PM1s (PM1-MOD2 through PM1-MOD6). In this case the application program is located in this VCMS2-PM1-CTRL1.

Modules may be ordered as VCMS2-PM1-MOD1, VCMS2-PM1-MOD2, VCMS2-PM1-MOD3, through MOD6 or as a VCMS2-PM1-CTRL1.

## Key Features

- Small Size, L-bracket mounting
- Eight 12 Volt 15 Amp Power Outputs (60A max per module)
- Eight Digital Inputs
- Modular/Expandable Design
- Remote Operation
- Programmable Control Logic Functions

## Related Products

- VCMS2-SM-4 thru SM-12 Switch Modules
- VCMS2-GM1 and CNTRL-1 Ground Out Modules

## Mechanical Drawing

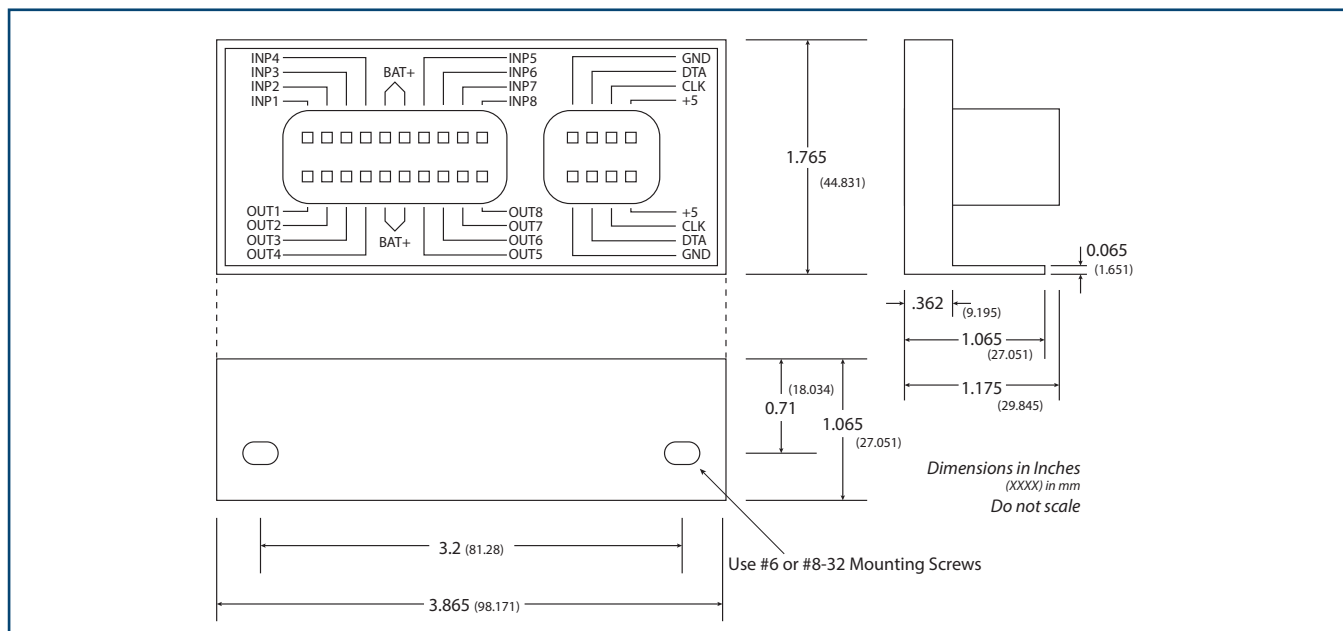

# VCMS2-PM1

## VCMS2-PM1-CTRL1

8 Input/ 8 Output Power Module  
With Molex Connectors

### Specifications

Dimensions:	Mounting Surface: 1.065 inches by 3.865 inches. 1.765 inches tall.
Case Material:	Anodized aluminum
Mounting:	Two #6-32 or #8-32 Mounting Screws through L bracket to a flat surface.
Mating Connectors:	One 20 pin A key Molex-150 (part # 33472-2001): inputs, outputs and power One 8 pin A key Molex 150 (part # 33472-0806): ground and data between modules
Outputs:	Eight high-side drivers rated for +12 volts @ 15 amps; max 60 amps per module
Inputs:	Eight programmable to pull up for ground true actuation or to pull down for +12 volt true actuation
Orderable Configurations:	VCMS2-PM1-CTRL1 (for Standalone systems (application)), VCMS2-PM1-MOD1, VCMS2-PM1-MOD2, VCMS2-PM1-MOD3, VCMS2-PM1-MOD4, VCMS2-PM1-MOD5, or VCMS2-PM1-MOD6.
Related Products:	VCMS2-SM4, VCMS2-SM6, VCMS2-SM8, VCMS2-SM10, VCMS2-SM12 switch modules, and VCMS2-GM1-CTRL1, VCMS2-GM1-MOD1, VCMS2-GM1-MOD2, VCMS2-GM1-MOD3, VCMS2-GM1-MOD4, VCMS2-GM1-MOD5, and VCMS2-GM1-MOD6,

### System Diagram

