



Life.

Safety.



UL Listed, True Constant Power
Emergency LED Drivers

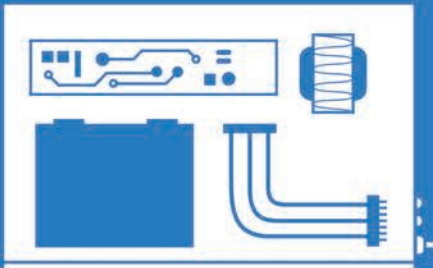

Mini and Micro
Emergency Inverter Systems



Energy Saving
Auxiliary Control Devices



Emergency Lighting Solutions

...for the reasons that matter most.



Whose Lives Are Counting On You?

IOTA Emergency Lighting Solutions help you bridge the critical gulf between Life Safety and functional lighting performance. Our innovations in emergency lighting design are engineered to confidently achieve the egress safety requirements you need to make your lighting projects a success for the reasons that matter most.





LED Emergency Drivers

IOTA's patented Constant Power ILB-CP emergency drivers combine powerful, non-diminishing emergency illumination with versatile driver and array compatibility for both field and factory installations. • [Page 6](#)



Emergency Ballasts for LED Retrofit and Fluorescent

Our emergency battery pack designs keep pace with today's evolving lighting demands and offer solutions for both standard fluorescent installations as well as popular energy-efficient LED retrofit tube lamp technology. • [Page 20](#)



Emergency Unit Inverters

IOTA IIS Series Mini and Micro Inverter solutions deliver full light output for virtually any interior or exterior lighting load from a single convenient auxiliary supply. • [Page 36](#)



Energy-Saving Emergency Control Devices

Increase energy savings by eliminating night-lights and always-on fixtures with IOTA ETS control devices. Utilize sensors, controls, and switches on designated emergency circuits without compromising occupant safety. • [Page 44](#)

Life. Safety.

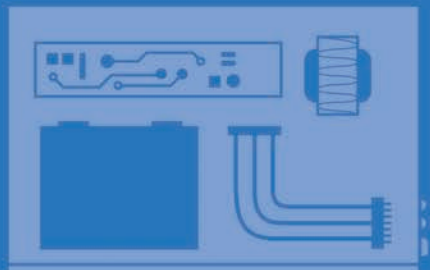



Delivering Solutions

By Understanding Your Project Demands

IOTA emergency lighting products are shaped by our extensive industry insight and expertise to ensure confident results for your lighting applications. Our understanding of Life Safety requirements and evolving technology is your resource for meeting your lighting project objectives.



LED Retrofit

Updating your existing lighting with LED technology? Emergency requirements will differ depending on the nature of your LED selection. Whether replacing fluorescent lamps with new LED tubes or inserting an entire LED retrofit kit into your fixture, IOTA can provide the optimal emergency solution you need. IOTA offers UL Listed emergency ballasts for qualified replacement LED tubes, field-install emergency drivers for Class 2 systems, and unit inverters for internal-driver lamps or chip-on-board array designs.

LED Retrofit Solutions - pg 22



CEC Title 20

Recent energy standards by the California Energy Commission (CEC) promote more sustainable utility practices by reducing unnecessary power consumption in lighting systems. IOTA has developed a unique micro-processor design that meets these efficiency standards without compromising emergency lighting performance. Look for the "HE" (high-efficiency) designator to identify IOTA emergency products that are registered with the CEC as qualified for use in the State of California.

Emergency Drivers - pg 10 Emergency Ballasts - pg 26 Inverter Systems - pg 39, 42

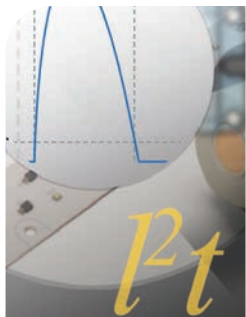

NEMA 410

NEMA 410 guidelines help specifiers and electricians determine proper operation of all components in their LED lighting systems. Several IOTA emergency products are carefully qualified to NEMA 410 standards for handling increased inrush in LED applications. IOTA's NEMA 410 products include IIS Inverter solutions as well as the ETS and ETS-20 emergency control devices for providing switching control on designated emergency LED loads.

Inverter Systems - pg 41 Auxiliary Control Devices - pg 47



Outdoor Paths of Egress

Outdoor paths of egress are an often-overlooked aspect of emergency lighting. Sufficient lighting must be provided so that occupants can reach a safe distance when exiting during an emergency. IOTA solutions for these harsher outdoor conditions include emergency battery packs with built-in protection against freezing and IIS Unit Inverters that can install indoors and remotely operate outdoor fixtures up to 1000 feet away.

Emergency Drivers - pg 15 **Emergency Ballasts** - pg 32 **Inverter Systems** - pg 40

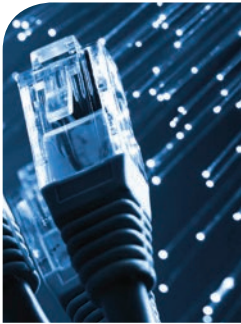

Power Over Ethernet Solutions

IOTA's revolutionary PoE emergency LED drivers provide critical Life Safety egress lighting for today's intelligent Power-over-Ethernet systems. IOTA PoE-CP12 drivers balance the sophisticated data and power requirements of PoE and IoT projects with Life Safety and NEC code compliance...delivering peace of mind for building occupants and confident performance for project designers.

Emergency Drivers - pg 13



Extended Run-times

Applications such as elevators or FEMA safe-room installations typically require emergency lighting run-times that extend beyond the standard 90-minute operation dictated by the Life Safety Code. IOTA IIS Inverters can extend run-times to meet these requirements simply by balancing the connected load size with the battery capacity. Additionally, IOTA offers both emergency LED driver and fluorescent emergency products for select two-hour performance applications.

Emergency Drivers - pg 14 **Inverter Systems** - pg 43



Dimming and Energy Savings

Lighting controls deliver both energy-saving benefits as well as personalization of your lighting space...and with IOTA control devices and product features, you can expand those benefits to accommodate your emergency lighting. IOTA's ETS models eliminate the excessive power consumption of Always-On fixtures by allowing the use of switches or occupancy sensors on designated emergency loads. Dimming relay options on IOTA IIS Inverters enable the use of 0-10Vdc dimming features on your emergency circuit.

Inverter Systems - pg 40-42 **Auxiliary Control Devices** - pg 47-48



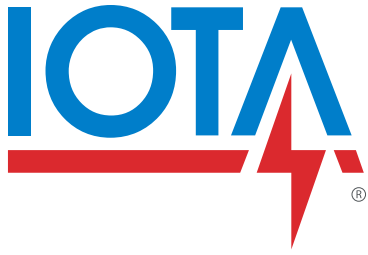

Emergency LED Drivers



IOTA's ILB-CP Series Emergency LED Drivers add confident emergency functionality to a wide range of both Class 2 and non-Class 2 LED luminaires. Combining patented Constant Power performance and auto-sensing output voltage with wattages from 5 to 20 watts, the ILB-CP Series provides a versatile and simplified solution for a variety of LED projects.





- **Superior Performance with True Constant Power**

IOTA's patented Constant Power design provides the same wattage to the LED array for the entire emergency run-time, resulting in no degradation of illumination while in the emergency mode.

- **UL Listed for both Field and Factory Installation**

The ILB-CP Series paved the way for field installation LED emergency drivers and are UL 924 Listed, UL Classified to FTBV in accordance with project, as-installed code requirements.

- **Versatile Compatibility with Auto-Sense Output**

The Auto-Sense Class 2 output of the ILB-CP Series will automatically adjust to match the forward voltage requirements of the LED array from 10-60VDC, simplifying the specification process and eliminating unnecessary output voltage SKUs.

- **Universal Voltage Input**

The ILB-CP Series features two-wire input that accepts voltages from 120 to 277 Vac, 50/60Hz, simplifying wiring and reducing installation errors.

- **RoHS Compliant**

IOTA's emergency LED drivers are responsibly designed and manufactured to RoHS standards for minimal environmental impact.



True Constant Power Performance

IOTA's patented Constant Power design provides the same wattage to the LED array for the entire emergency runtime, resulting in no degradation of illumination while in the emergency mode.

ILB-CP05

5 WATT OUTPUT

Input Voltage
120-277VAC, 50/60Hz

Input Rating
2.7 Watts (max)

Output Voltage Range
10-60VDC Class 2 Compliant

Output Current
0.5A (@10Vdc) - 0.08A (@60Vdc)

Output Power (constant)
5 Watts

Power Factor
≥ 0.9

Emergency Operation
90 minutes

Operating Temp
0° to 55° C

THD
< 20%

Battery
High-Temp Nickel-Cadmium
24 Hour Recharge
7-10 Year Life Expectancy

Weight
(-A, -R) 3.0 lbs.
(-B, -TM) 2.5 lbs.
(-J, -RJ) 2.75 lbs.

Certifications
UL and cUL Listed
for field and factory installation.

Dimensions
9.5" x 2.4" x 1.5"
(mounting center 9.0")

ILB-CP07

7 WATT OUTPUT

Input Voltage
120-277VAC, 50/60Hz

Input Rating
3.5 Watts (max)

Output Voltage Range
10-60VDC Class 2 Compliant

Output Current
0.7A (@10Vdc) - 0.12A (@60Vdc)

Output Power (constant)
7 Watts

Power Factor
≥ 0.9

Emergency Operation
90 minutes

Operating Temp
0° to 55° C

THD
< 20%

Battery
High-Temp Nickel-Cadmium
24 Hour Recharge
7-10 Year Life Expectancy

Weight
(-A, -R) 3.0 lbs.
(-B, -TM) 2.5 lbs.
(-J, -RJ) 2.75 lbs.

Certifications
UL and cUL Listed
for field and factory installation.

Dimensions
13.0" x 2.2" x 1.25"*
(mounting center 12.6")

*Length is 13.3" for "TM" Configuration

ILB-CP10

10 WATT OUTPUT

Input Voltage
120-277VAC, 50/60Hz

Input Rating
3.7 Watts (max)

Output Voltage Range
10-60VDC Class 2 Compliant

Output Current
1.0A (@10Vdc) - 0.16A (@60Vdc)

Output Power (constant)
10 Watts

Power Factor
≥ 0.9

Emergency Operation
90 minutes

Operating Temp
0° to 55° C

THD
< 20%

Battery
High-Temp Nickel-Cadmium
24 Hour Recharge
7-10 Year Life Expectancy

Weight
(-A, -R) 4.0 lbs.
(-B, -TM) 3.5 lbs.
(-J, -RJ) 3.75 lbs.

Certifications
UL and cUL Listed
for field and factory installation.

Dimensions
13.3" x 2.375" x 1.5"
(mounting center 12.75")

-B: 13.0" x 2.2" x 1.25"
(mounting center 12.6")

ILB-CP12

12 WATT OUTPUT

Input Voltage
120-277VAC, 50/60Hz

Input Rating
3.7 Watts (max)

Output Voltage Range
10-60VDC Class 2 Compliant

Output Current
1.2A (@10Vdc) - 0.2A (@60Vdc)

Output Power (constant)
12 Watts

Power Factor
≥ 0.9

Emergency Operation
90 minutes

Operating Temp
0° to 55° C

THD
< 20%

Battery
High-Temp Nickel-Cadmium
24 Hour Recharge
7-10 Year Life Expectancy

Weight
(-A, -R) 4.0 lbs.
(-B, -TM) 3.5 lbs.
(-J, -RJ) 3.75 lbs.

Certifications
UL and cUL Listed
for field and factory installation.

Dimensions
13.3" x 2.375" x 1.5"
(mounting center 12.75")

-B: 13.0" x 2.2" x 1.25"
(mounting center 12.6")



Designed for Superior Performance

IOTA Emergency Lighting Products are engineered and manufactured for reliable performance in your egress applications...see Page 18 for more product details.

- Versatile mounting designs
- Single-piece test switch and charge indicator
- Rated for damp location and enclosed & gasketed fixtures
- Galvanized steel construction
- RoHS compliant
- 5-Year Warranty



EMERGENCY LED DRIVERS

Slim Profile

ILB-SL-CP05	ILB-SL-CP07	ILB-SL-CP10	ILB-SL-CP12
5 WATT OUTPUT	7 WATT OUTPUT	10 WATT OUTPUT	12 WATT OUTPUT
Input Voltage 120-277VAC, 50/60Hz	Input Voltage 120-277VAC, 50/60Hz	Input Voltage 120-277VAC, 50/60Hz	Input Voltage 120-277VAC, 50/60Hz
Input Rating 2.7 Watts (max)	Input Rating 3.5 Watts (max)	Input Rating 3.7 Watts (max)	Input Rating 3.7 Watts (max)
Output Voltage Range 10-60VDC Class 2 Compliant	Output Voltage Range 10-60VDC Class 2 Compliant	Output Voltage Range 10-60VDC Class 2 Compliant	Output Voltage Range 10-60VDC Class 2 Compliant
Output Current 0.5A (@10Vdc) - 0.08A (@60Vdc)	Output Current 0.7A (@10Vdc) - 0.12A (@60Vdc)	Output Current 1.0A (@10Vdc) - 0.16A (@60Vdc)	Output Current 1.2A (@10Vdc) - 0.2A (@60Vdc)
Output Power (constant) 5 Watts	Output Power (constant) 7 Watts	Output Power (constant) 10 Watts	Output Power (constant) 12 Watts
Power Factor ≥ 0.9	Power Factor ≥ 0.9	Power Factor ≥ 0.9	Power Factor ≥ 0.9
Emergency Operation 90 minutes	Emergency Operation 90 minutes	Emergency Operation 90 minutes	Emergency Operation 90 minutes
Operating Temp 0° to 55° C	Operating Temp 0° to 55° C	Operating Temp 0° to 55° C	Operating Temp 0° to 55° C
THD < 20%	THD < 20%	THD < 20%	THD < 20%
Battery High-Temp Nickel-Cadmium 24 Hour Recharge 7-10 Year Life Expectancy	Battery High-Temp Nickel-Cadmium 24 Hour Recharge 7-10 Year Life Expectancy	Battery High-Temp Nickel-Cadmium 24 Hour Recharge 7-10 Year Life Expectancy	Battery High-Temp Nickel-Cadmium 24 Hour Recharge 7-10 Year Life Expectancy
Weight 2.4 lbs.	Weight 3.0 lbs.	Weight 3.5 lbs.	Weight 3.5 lbs.
Certifications UL and cUL Listed for field and factory installation.	Certifications UL and cUL Listed for field and factory installation.	Certifications UL and cUL Listed for field and factory installation.	Certifications UL and cUL Listed for field and factory installation.
Dimensions 16.5" x 1.54" x 1.2" (mounting center 16.07")	Dimensions 22.44" x 1.2 x 1.2" (mounting center 22.0")	Dimensions 24.17" x 1.2" x 1.2" (mounting center 23.78")	Dimensions 24.17" x 1.2" x 1.2" (mounting center 23.78")

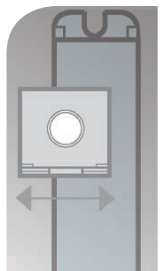

IOTA's Slim Profile "SL" emergency drivers feature the same performance as IOTA's other field-install constant power solutions, but feature a narrow enclosure. IOTA's "SL" emergency drivers were the first constant power and field-installable solutions to feature a narrow, galvanized steel enclosure for installations with limited compartment space. The innovative design merited selection of the ILB-SL-CP12 for the 2014 IES Progress Report. Although designed for integral installation, SL models can also be top-mounted when used in conjunction with the TMK-ISL mounting accessory.



BC High-Efficiency Design - Minimizes Power Consumption and Certified to CA Title 20 Performance Standards

ILB-CP05-HE

5 WATT OUTPUT

Input Voltage
120-277VAC, 50/60Hz

Input Rating
2.3 Watts (max)

Output Voltage Range
10-60VDC Class 2 Compliant

Output Current
0.5A (@10Vdc) to
0.08A (@60Vdc)

Output Power (constant)
5 Watts

Power Factor
≥ 0.9 @120Vac
≥ 0.8 @277Vac

Emergency Operation
90 minutes

Operating Temp
0° to 55° C

THD
< 10% (@ full charge)

Battery
High-Temp Nickel-Cadmium
24 Hour Recharge
7-10 Year Life Expectancy

Weight
(-A, -R) 3.0 lbs.
(-B, -TM) 2.5 lbs.
(-J, -RJ) 2.75 lbs.

Certifications
UL and cUL Listed for
field and factory installation.
California Title 20

Dimensions
-A 14.95" x 2.2" x 1.375"
(mounting center 14.5")
-B 13.88" x 2.2" x 1.2"
(mounting center 13.5")

ILB-CP07-HE

7 WATT OUTPUT

Input Voltage
120-277VAC, 50/60Hz

Input Rating
2.7 Watts (max)

Output Voltage Range
10-60VDC Class 2 Compliant

Output Current
0.7A (@10Vdc) to
0.12A (@60Vdc)

Output Power (constant)
7 Watts

Power Factor
≥ 0.9 @120Vac
≥ 0.8 @277Vac

Emergency Operation
90 minutes

Operating Temp
0° to 55° C

THD
< 10% (@ full charge)

Battery
High-Temp Nickel-Cadmium
24 Hour Recharge
7-10 Year Life Expectancy

Weight
(-A, -R) 4.0 lbs.
(-B, -TM) 3.5 lbs.
(-J, -RJ) 3.75 lbs.

Certifications
UL and cUL Listed for
field and factory installation.
California Title 20

Dimensions
-A 15.37" x 2.24" x 1.30"
(mounting center 15.0")
-B 15.0" x 2.2" x 1.2"
(mounting center 14.64")

ILB-CP10-HE

10 WATT OUTPUT

Input Voltage
120-277VAC, 50/60Hz

Input Rating
3.7 Watts (max)

Output Voltage Range
10-60VDC Class 2 Compliant

Output Current
1.0A (@10Vdc) to
0.16A (@60Vdc)

Output Power (constant)
10 Watts

Power Factor
≥ 0.9 @120Vac
≥ 0.85 @277Vac

Emergency Operation
90 minutes

Operating Temp
0° to 55° C

THD
< 20%

Battery
High-Temp Nickel-Cadmium
24 Hour Recharge
7-10 Year Life Expectancy

Weight
(-A, -R) 4.0 lbs.
(-B, -TM) 3.5 lbs.
(-J, -RJ) 3.75 lbs.

Certifications
UL and cUL Listed for
field and factory installation.
California Title 20

Dimensions
-A 15.37" x 2.24" x 1.30"
(mounting center 15.0")
-B 15.0" x 2.2" x 1.2"
(mounting center 14.64")

ILB-SL-CP08-HE

8 WATT OUTPUT

Input Voltage
120-277VAC, 50/60Hz

Input Rating
2.9 Watts (max)

Output Voltage Range
10-60VDC Class 2 Compliant

Output Current
0.8A (@10Vdc) to
0.13A (@60Vdc)

Output Power (constant)
8 Watts

Power Factor
≥ 0.9 @120Vac
≥ 0.75 @277Vac

Emergency Operation
90 minutes

Operating Temp
0° to 55° C

THD
< 15% (@ full charge)

Battery
High-Temp Nickel-Cadmium
24 Hour Recharge
7-10 Year Life Expectancy

Weight
2.25 lbs.

Certifications
UL and cUL Listed for
field and factory installation.
California Title 20

Dimensions
22.17" x 1.18" x 1.18"
(mounting center 21.77")

Slim Profile

ILB-SL-CP10-HE

10 WATT OUTPUT

Input Voltage
120-277VAC, 50/60Hz

Input Rating
3.7 Watts (max)

Output Voltage Range
10-60VDC Class 2 Compliant

Output Current
1.0A (@10Vdc) to
0.16A (@60Vdc)

Output Power (constant)
10 Watts

Power Factor
≥ 0.9 @120Vac
≥ 0.85 @277Vac

Emergency Operation
90 minutes

Operating Temp
0° to 55° C

THD
< 20%

Battery
High-Temp Nickel-Cadmium
24 Hour Recharge
7-10 Year Life Expectancy

Weight
3.0 lbs.

Certifications
UL and cUL Listed for
field and factory installation.
California Title 20

Dimensions
26.75" x 1.18" x 1.18"
(mounting center 26.33")

Slim Profile



Designed for Superior Performance

IOTA Emergency Lighting Products are engineered and manufactured for reliable performance in your egress applications...see Page 18 for more product details.

- Versatile mounting designs
- Single-piece test switch and charge indicator
- Rated for damp location and enclosed & gasketed fixtures
- Galvanized steel construction
- RoHS compliant
- 5-Year Warranty



EMERGENCY LED DRIVERS

BC High-Efficiency Design - Minimizes Power Consumption and Certified to CA Title 20 Performance Standards

ILB-CP10-HE-SD

10 WATT OUTPUT

Input Voltage
120-277VAC, 50/60Hz

Input Rating
3.7 Watts (max)

Output Voltage Range
10-60VDC Class 2 Compliant

Output Current
1.0A (@10Vdc) - 0.16A (@60Vdc)

Output Power (constant)
10 Watts

Power Factor
≥ 0.9 @ 120Vac, ≥ 0.85 @ 277Vac

Emergency Operation
90 minutes

Operating Temp
0° to 55° C

THD
< 20%

Battery
High-Temp Nickel-Cadmium
24 Hour Recharge
7-10 Year Life Expectancy

Weight
(-A, -R) 4.0 lbs.
(-B, -TM) 3.5 lbs.
(-J, -RJ) 3.75 lbs.

Certifications
UL and cUL Listed for field and factory installation.
California Title 20

Dimensions
-A 15.37" x 2.24" x 1.30"
(mounting center 15.0")
-B 15.0" x 2.2" x 1.2"
(mounting center 14.64")

Self-Diagnostic Capability

ILB-CP20-HE

20 WATT OUTPUT

Input Voltage
120-277VAC, 50/60Hz

Input Rating
5.5 Watts (max)

Output Voltage Range
20-60VDC Class 2 Compliant

Output Current
1.0A (@20Vdc) - 0.3A (@60Vdc)

Output Power (constant)
20 Watts

Power Factor
≥ 0.85

Emergency Operation
90 minutes

Operating Temp
0° to 55° C

THD
< 20%

Battery
High-Temp Nickel-Cadmium
24 Hour Recharge
7-10 Year Life Expectancy

Weight
(dual flex -A, -R) 6.0 lbs.
(single flex -S) 5.7 lbs.

Certifications
UL and cUL Listed for field and factory installation.
California Title 20

Dimensions
17.75" x 2.5" x 2.375"
(mounting center 17.2")

ILB-CP20-HE-SD

20 WATT OUTPUT

Input Voltage
120-277VAC, 50/60Hz

Input Rating
5.5 Watts (max)

Output Voltage Range
20-60VDC Class 2 Compliant

Output Current
1.0A (@20Vdc) - 0.3A (@60Vdc)

Output Power (constant)
20 Watts

Power Factor
≥ 0.85

Emergency Operation
90 minutes

Operating Temp
0° to 55° C

THD
< 20%

Battery
High-Temp Nickel-Cadmium
24 Hour Recharge
7-10 Year Life Expectancy

Weight
(dual flex -A, -R) 6.0 lbs.
(single flex -S) 5.7 lbs.

Certifications
UL and cUL Listed for field and factory installation.
California Title 20

Dimensions
17.75" x 2.5" x 2.375"
(mounting center 17.2")

Self-Diagnostic Capability

ILB-CP20-HE-HV

20 WATT OUTPUT

Input Voltage
120-277VAC, 50/60Hz

Input Rating
5.5 Watts (max)

Output Voltage Range
50-200VDC

Output Current
0.4A (@50Vdc) - 0.1A (@200Vdc)

Output Power (constant)
20 Watts

Max. AC Driver Output Current
5Adc

Power Factor
≥ 0.85

Emergency Operation
90 minutes

Operating Temp
0° to 55° C

THD
< 20%

Battery
High-Temp Nickel-Cadmium
24 Hour Recharge
7-10 Year Life Expectancy

Weight
(dual flex -A, -R) 6.0 lbs.
(single flex -S) 5.7 lbs.

Certifications
UL and cUL Listed for field and factory installation.
California Title 20

Dimensions
17.75" x 2.5" x 2.375"
(mounting center 17.2")

High Voltage Output



Self-Diagnostic

Provides automatic monthly and annual testing to ensure proper operation and Life Safety compliance. The self-diagnostic function confirms operational status of the internal battery, battery charger circuit, and LED load. Should an error be encountered, the self-diagnostic unit will communicate the type of error via pre-determined blinking codes of the dual-color lighted test switch.



High Voltage Output

The ILB-CP20-HE-HV design is compatible with non-Class 2 LED loads operating between 50 to 200VDC, in addition to meeting CA Title 20 requirements.



LOW PROFILE
LITHIUM TECHNOLOGY

Self-Diagnostics
Certified CA Title 20



AVAILABLE
THIRD QUARTER

Low Profile Design for Significant Performance with Minimal Footprint

10-WATT

15-WATT

ILB-LP-CP10-HE-SD

ILB-LP-CP10-HE-SD-N

ILB-LP-CP10-HE-SD-NP

ILB-LP-CP15-HE-SD

ILB-LP-CP15-HE-SD-N

Input Voltage
120-277VAC, 50/60Hz

Input Rating
25mA

Output Voltage Range
10-55VDC Class 2 Compliant

Output Current
1.0A (@10Vdc) to
0.18 (@55Vdc)

Output Power (constant)
10 Watts

Emergency Operation
90 minutes

Operating Temp
5° to 50° C

Battery
Lithium Iron-Phosphate
24 Hour Recharge
5-7 Year Life Expectancy

Weight
Dual flex (-A) 2.5 lbs
No flex (-B) 1.5 lbs

Certifications
UL Listed for field and
factory installation.
California Title 20

Dimensions
10.5" x 2.34" x 1.18"
(mounting center 10.0 x 1.1")

Input Voltage
120-277VAC, 50/60Hz

Input Rating
25mA

Output Voltage Range
10-55VDC Class 2 Compliant

Output Current
1.0A (@10Vdc) to
0.18 (@55Vdc)

Output Power (constant)
10 Watts

Emergency Operation
90 minutes

Operating Temp
5° to 50° C

Battery
Lithium Iron-Phosphate
24 Hour Recharge
5-7 Year Life Expectancy

Weight
1.5 lbs

Certifications
UL Listed for field and
factory installation.
California Title 20

Dimensions
16.7" x 1.19" x 1.18"
(mounting center 16.2")

Input Voltage
120-277VAC, 50/60Hz

Input Rating
25mA

Output Voltage Range
10-60VDC Class 2 Compliant

Output Current
1.0A (@10Vdc) to
0.16A (@60Vdc)

Output Power (constant)
10 Watts

Emergency Operation
90 minutes

Operating Temp
0° to 55° C

Battery
Lithium Iron-Phosphate
24 Hour Recharge
5-7 Year Life Expectancy

Weight
1.5 lbs

Certifications
UL Listed for field and
factory installation.
California Title 20

Dimensions
16.7" x 1.19" x 1.18"
(mounting center 16.2")

Narrow Profile

Poke-In Connections

Input Voltage
120-277VAC, 50/60Hz

Input Rating
22mA

Output Voltage Range
20-55VDC Class 2 Compliant

Output Current
0.75A (@20Vdc) to
0.25A (@55Vdc)

Output Power (constant)
15 Watts

Emergency Operation
90 minutes

Operating Temp
5° to 50° C

Battery
Lithium Iron-Phosphate
24 Hour Recharge
5-7 Year Life Expectancy

Weight
Dual flex (-A) 3.25 lbs
No flex (-B) 2.25 lbs

Certifications
UL Listed for field and
factory installation.
California Title 20

Dimensions
14.7" x 2.34" x 1.18"
(mounting center 14.1 x 1.1")

Flex / Non-Flex Options

Input Voltage
120-277VAC, 50/60Hz

Input Rating
22mA

Output Voltage Range
20-55VDC Class 2 Compliant

Output Current
0.75A (@20Vdc) to
0.25A (@55Vdc)

Output Power (constant)
15 Watts

Emergency Operation
90 minutes

Operating Temp
5° to 50° C

Battery
Lithium Iron-Phosphate
24 Hour Recharge
5-7 Year Life Expectancy

Weight
2 lbs

Certifications
UL Listed for field and
factory installation.
California Title 20

Dimensions
22" x 1.18" x 1.18"
(mounting center 21.5")

Narrow Profile

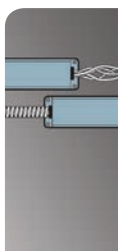

Flex / Non-Flex Options

The ILB-LP-CP designs offer both dual flex and integral non-flex designs to accommodate your luminaire requirements. Dual Flex models are designated with the ending suffix "-A" and Non-Flex units with the suffix "-B". Refer to page 19 for details.



Poke-In Connections

The specialized poke-in terminals of the ILB-LP "NP" configuration are ideal for easily eliminating excess wiring and need for wire connectors within narrow compartments where space is at a premium.



Self-Diagnostic

ILB-LP models provide automatic testing to help ensure proper operation and Life Safety compliance. If an error is encountered, the unit will communicate via blinking of the lighted test switch.

The Ground-Breaking Solution for Today's Smart Lighting Systems!



LFI 2018 Winner
Best in Category
Ballasts, Transformers, Drivers, Systems and Kits

For PoE / IoT Luminaires

PoE-CP12

POWER-OVER-ETHERNET

Input Voltage (Battery Charger Port)
37Vdc - 57Vdc (48Vdc nom.)

Input Wattage (Battery Charger Port)
4W (max)

Input Voltage (Battery Charger Port)
IEEE802.3af and IEEE802.3at Standards

Output Voltage
10-60Vdc

Output Power
12W (constant)

Emergency Operation
90 minutes

Operating Temp
Standard: 0° to 50° C

Battery
High-Temp Nickel-Cadmium
24 Hour Recharge
7-10 Year Life Expectancy

Weight
2.7 lbs.

Approval
UL Listed as an LED emergency driver for field and factory installation



Dimensions
15.6" x 2.8" x 1.2"
(mounting center 15.2" x 1.6")

Configurations

Two configurations are available for connections to the luminaire driver and LED array:
[PoE-CP12-V1A \(standard hardware\)](#)
Features two 20AWG stranded hardwire lead (approx 36 inch length)

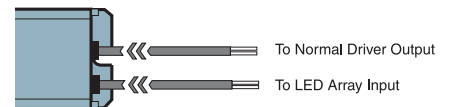

PoE-CP12-V1B (RJ-45)

Contact Customer Service for details on specialized RJ-45 connections.

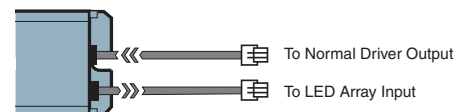

- PoE Compatible, UL 924 Emergency LED Driver**

The PoE-CP12 is a UL 924 Listed Emergency LED Driver compatible with PoE lighting luminaires, and compliant with IEEE 802.3 PoE Standard Systems to deliver required emergency egress performance to your PoE lighting.

- Data Integrity**

Connected IoT driver systems operate perfectly with data safeguarded against electrical interference. The PoE-CP12 monitors the normal input power status while seamlessly allowing transmission of luminaire data.

- Proper Power Management**

Intelligently controlled battery charging ensures your emergency lighting system performs within the PoE PSE power management parameters to maintain a state of readiness and proper function.

- Confident Life Safety Compliance**

The PoE-CP12 emergency LED driver delivers dependable Life Safety emergency egress performance within the sophisticated framework of today's IoT and PoE applications.

Connections

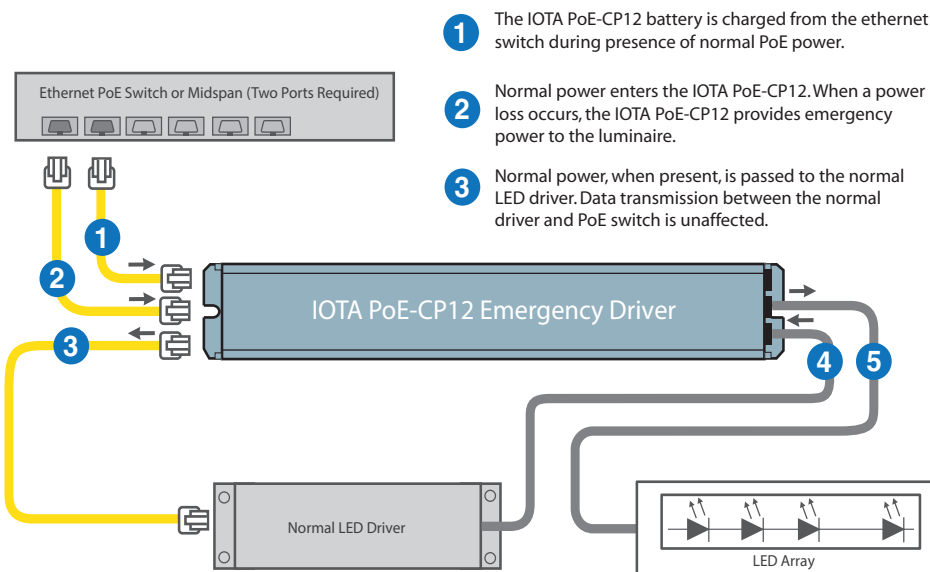

- The IOTA PoE-CP12 battery is charged from the ethernet switch during presence of normal PoE power.
- Normal power enters the IOTA PoE-CP12. When a power loss occurs, the IOTA PoE-CP12 provides emergency power to the luminaire.
- Normal power, when present, is passed to the normal LED driver. Data transmission between the normal driver and PoE switch is unaffected.

4 The PoE-CP12 electrically exists between the normal LED driver and LED array. Normal Power passes through from the driver to the array via hardwire connections or RJ-45 connectors, depending on the model.

5 The LED array is powered by the Normal LED Driver during normal power conditions. The LED array is powered from the PoE-CP12 when normal power fails, ensuring occupants receive proper illumination at all times.



United States Patents
US 9,609,706 B2
US 9,941,737 B2

Specialty Constant Power Designs



ILB-CP07-2H

2-HOUR OPERATION

Input Voltage
120-277VAC, 50/60Hz

Input Rating
3.7 Watts (max)

Output Voltage Range
10-60VDC Class 2 Compliant

Output Current
0.7A (@10Vdc) - 0.12A (@60Vdc)

Output Power (constant)
7 Watts

Power Factor
≥ 0.9

Emergency Operation
120 minutes per FEMA requirements

Operating Temp
0° to 55° C

THD
< 20%

Battery
High-Temp Nickel-Cadmium
24 Hour Recharge
7-10 Year Life Expectancy

Weight
(-A) 4.0 lbs.
(-B) 3.5 lbs.

Certifications
UL and cUL Listed for field and factory installation.

Dimensions
-A 13.3" x 2.375" x 1.5"
(mounting center 12.75")
-B 13.0" x 2.2" x 1.25"
(mounting center 12.6")

2-Hour Operation

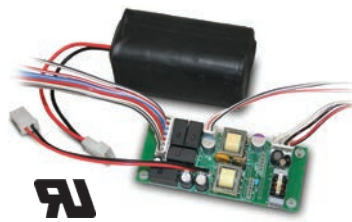

ILB-CP10-L

OPEN BOARD 10 WATT

Input Voltage
120-277VAC, 50/60Hz

Input Rating
3.7 Watts (max)

Output Voltage Range
10-60VDC Class 2 Compliant

Output Current
1.0A (@10Vdc) - 0.16A (@60Vdc)

Output Power (constant)
10 Watts

Power Factor
≥ 0.9

Emergency Operation
90 minutes

Operating Temp
0° to 55° C

THD
< 20%

Battery
High-Temp Nickel-Cadmium
24 Hour Recharge
7-10 Year Life Expectancy

Weight
3.5 lbs

Certifications
UL Component Recognized for Factory Installation.

Dimensions
Board:
4.625" x 1.875" x 1.25"
Battery:
2.125" x 2.125" x 4.125"

Open Board Design



ILB-CP10-LC

EXTERNAL BATTERY

Input Voltage
120-277VAC, 50/60Hz

Input Rating
3.7 Watts (max)

Output Voltage Range
10-60VDC Class 2 Compliant

Output Current
1.0A (@10Vdc) - 0.16A (@60Vdc)

Output Power (constant)
10 Watts

Power Factor
≥ 0.9

Emergency Operation
90 minutes

Operating Temp
0° to 55° C

THD
< 20%

Battery
High-Temp Nickel-Cadmium
24 Hour Recharge
7-10 Year Life Expectancy

Weight
3.5 lbs

Certifications
UL Component Recognized for Factory Installation.

Dimensions
Electronics Enclosure:
4.625" x 1.875" x 1.25"
Battery:
2.125" x 2.125" x 4.125"

External Battery



ILB-LP-CP15-HE-SD-LC

EXTERNAL LOW PROFILE

Input Voltage
120-277VAC, 50/60Hz

Input Rating
22mA

Output Voltage Range
20-55VDC Class 2 Compliant

Output Current
0.75A (@20Vdc) to 0.25A (@55Vdc)

Output Power (constant)
15 Watts

Emergency Operation
90 minutes

Operating Temp
5° to 50° C

Battery
Lithium Iron-Phosphate
24 Hour Recharge
5-7 Year Life Expectancy

Weight
2 lbs

Certifications
UL Component Recognized for Factory Installation
California Title 20

Dimensions
Electronics enclosure:
8.64" x 1.18" x 1.18"

Battery:
(Length) 13.13" x (Diameter) 1.04"

Certified CA Title 20

Self-Diagnostics

External Lithium Battery

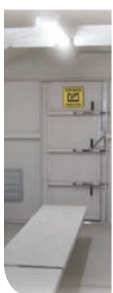

Designed to meet FEMA 2-hour operation requirements in tornado safe rooms. The two-hour runtime combined with the non-diminishing constant power performance make the ILB-CP07-2H an ideal solution for these applications.

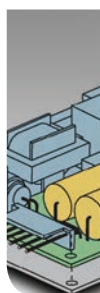

The open board ILB-CP10-L emergency driver provides versatility for OEM fixture designs. Includes the charger and inverter circuit board with separate battery for mounting within the fixture. UL Component Recognized for factory installation only.

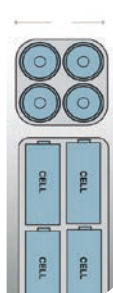

The ILB-CP10-LC features an external battery with electronic circuitry enclosed in a minimal galvanized housing for integral installation with the fixture. UL Component Recognized for factory installation only.



IOTA "LP" products use lithium-based battery technology to deliver Constant Power performance with a significantly decreased product footprint, making it ideal for low profile luminaire designs.



ILB-1826

CONSTANT CURRENT DRIVER

Input Voltage

(Dual) 120/277 VAC, 60Hz

Input Rating

Standard model: 5.5 Watts

Cold-Weather: 86W (w/ heating element on)

Output Voltage

18-26VDC

Output Current

750 mA (constant)

Output Power

Up to 20W (max)

Power Factor

≥ 0.9

Emergency Operation

90 minutes

Operating Temp

Standard: 0° to 50° C

Cold-Weather: -20° to 50° C

Battery

High-Temp Nickel-Cadmium

24 Hour Recharge

7-10 Year Life Expectancy

Weight

4.0 lbs.

Certifications

UL Component Recognized for Factory Installation.



Dimensions

Enclosure: 9.5" x 2.0" x 1.0"

Battery: 6.0" x 1.7" x 2.5" (x2)

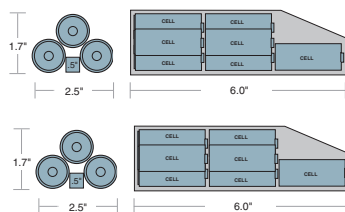

The ILB-1826 features (2) 7-cell battery packs that connect to the galvanized steel enclosure. For cold-weather versions, add approx. 1/8" to battery dimensions to account for the external battery heating blanket.



ILB-3020

CONSTANT CURRENT DRIVER

Input Voltage

(Dual) 120/277 VAC, 60Hz

Input Rating

Standard model: 5.5 Watts

Cold-Weather: 86W (w/ heating element on)

Output Voltage

27-33VDC

Output Current

600 mA (constant)

Output Power

Up to 20W (max)

Power Factor

≥ 0.9

Emergency Operation

90 minutes

Operating Temp

Standard: 0° to 50° C

Cold-Weather: -20° to 50° C

Battery

High-Temp Nickel-Cadmium

24 Hour Recharge

7-10 Year Life Expectancy

Weight

4.0 lbs.

Certifications

UL Component Recognized for Factory Installation.



Dimensions

Enclosure: 9.5" x 2.0" x 1.0"

Battery (single): 2.125" x 2.125" x 4.125"

Battery (dual): 2.125" x 2.125" x 4.125" ea.

Dual battery

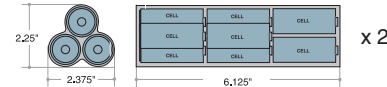

Single battery

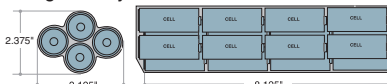

The ILB-3020 offers two battery profile options: (1) 16-cell battery pack or (2) 8-cell packs. For cold-weather versions, add approx. 1/8" to battery dimensions to account for the external battery heating blanket.

Constant Current and Cold-Weather

Constant current emergency LED drivers provide external battery configurations for versatile factory installations as well as optional cold-weather and IP-rated performance.



COLD WEATHER OPTION (-CW)

Cold-weather battery packs are designed specifically for use in applications such as outdoor egress or other freezing environments.

HEATING BLANKET

The specialized heating blanket protects the battery from extreme temperatures. When the temperature drops, the heating blanket is activated and maintains the battery temperature within operable parameters.

TEMPERATURE CONTROL CIRCUITRY

The temperature control circuitry activates the heating blanket at low temperatures and also ensures the battery temperature has reached acceptable levels before initiating the charging circuit.



IP67 RATING FOR ILB-3020-CW

An IP67-rated model of the ILB-3020-CW is also available for meeting specified ingress protection requirements. The specialized IP67 ILB-3020-CW features an IP-rated test switch that is suitable for accessible installation within IP fixture designs.

Understanding True Constant Power



CP CONSTANT POWER
EMERGENCY OUTPUT

Desired Lumen Output

	400	500	600	700	800	900	1000
80	CP05	CP07	CP08	CP10	CP10	CP12	CP15
90	CP05	CP07	CP07	CP08	CP10	CP10	CP12
100	CP05	CP05	CP07	CP07	CP08	CP10	CP10
110	CP05	CP05	CP05	CP07	CP08	CP10	CP10
120	CP05	CP05	CP05	CP07	CP07	CP08	CP10
130	CP05	CP05	CP05	CP07	CP07	CP07	CP08
140	CP05	CP05	CP05	CP05	CP07	CP07	CP08
150	CP05	CP05	CP05	CP05	CP07	CP07	CP07
160	CP05	CP05	CP05	CP05	CP05	CP07	CP07
170	CP05	CP05	CP05	CP05	CP05	CP07	CP07
180	CP05	CP05	CP05	CP05	CP05	CP05	CP07

Luminaire Efficacy (lm/w)

CP05 - 5-Watt

CP07 - 7-Watt

CP08 - 8-Watt

Simplified Lumen Performance

The ILB-CP Constant Power performance simplifies the specification process by making it easy to determine the actual lumen output. To calculate lumen performance, multiple your luminaire's published **efficacy (lumens per watt)** by the **output wattage** of the ILB-CP emergency driver.

Formula: $L/W \times CP \text{ Wattage} = EM \text{ Lumens}$

Example: $119 \times 12 = 1428 \text{ Lumens}$

Insert indicated efficacy from luminaire specification...



Insert the wattage of your IOTA ILB-CP unit...



and calculate!



How True Constant Power minimizes cost...

Since the output of the ILB-CP is constant, the final lumen calculation is the full lumen value during Minute 1 through Minute 90 of the emergency runtime. Therefore, it is not necessary to 'over-compensate' for diminishing light output (ie. specify a 7-watt emergency driver to ensure it is delivering 5 watts at the end of the required 90 minute runtime.)

Auto-Sensing Forward Voltage



Simplified Model Selection with Wider Voltage Range Capability...

The IOTA ILB-CP Series features **Class 2 Compliant output of 10-60 volts** and 50-200 volts on the **ILB-CP20-HE-HV for non-Class 2** applications. The ILB-CP operates the LED array safely by automatically adjusting the forward voltage to accommodate any voltage fluctuations caused by temperature, age, or manufacturer component variances within the LED system.

The wider forward voltage range of the ILB-CP makes it **widely compatible with most any Class 2 driver** for easier specifying. Additionally, the ability to operate a full range of Class 2 LED loads **eliminates unnecessary voltage SKUs** in your emergency driver inventory.

Desired Lumen Output

1100	1200	1300	1400	1500	1600	1700	1800	1900	2000	2100	2200 to 3600*
CP15	CP15	CP20	CP20	CP20	CP20	n/a	n/a	n/a	n/a	n/a	n/a
CP15	CP15	CP15	CP20	CP20	CP20	CP20	CP20	n/a	n/a	n/a	n/a
CP12	CP12	CP15	CP15	CP15	CP20	CP20	CP20	CP20	CP20	n/a	n/a
CP10	CP12	CP12	CP15	CP15	CP15	CP20	CP20	CP20	CP20	CP20	CP20
CP10	CP10	CP12	CP12	CP15	CP15	CP15	CP15	CP20	CP20	CP20	CP20
CP10	CP10	CP10	CP12	CP12	CP15	CP15	CP15	CP15	CP20	CP20	CP20
CP08	CP10	CP10	CP10	CP12	CP12	CP15	CP15	CP15	CP15	CP15	CP20
CP08	CP08	CP10	CP10	CP10	CP12	CP12	CP12	CP15	CP15	CP15	CP15
CP07	CP08	CP10	CP10	CP10	CP10	CP12	CP12	CP12	CP15	CP15	CP15
CP07	CP08	CP08	CP10	CP10	CP10	CP10	CP12	CP12	CP12	CP15	CP15
CP07	CP07	CP08	CP08	CP10	CP10	CP10	CP10	CP12	CP12	CP12	CP15

CP10 -10-Watt

CP12 - 12-Watt

CP15 - 15-Watt

CP20 - 20-Watt

*Options shown are for 2200 lumen levels. For lumen values above 2200, multiply fixture efficacy by 20 to determine output levels of CP20 or by 15 for CP15 models.

UL Listed for Field and Factory Installation

The innovative ILB-CP Series paved the way for field installation LED emergency drivers and are UL 924 Listed, UL Classified to FTBV in accordance with project, as-installed code requirements. The patented Constant Power design simplifies the specification process by providing predictable, non-degrading lumen performance. Additionally, the auto-sensing Class 2 output provides wider compatibility to accommodate 10 to 60Vdc LED loads. Selecting the right ILB-CP Emergency Driver for your project is simple:

Verify Electrical Compatibility

Confirm the required voltage of the LED load (Class 2 or Non-Class 2) and select the appropriate emergency driver (standard ILB-CP designs for Class 2 and ILB-CP20-HE-HV for 50-100vdc.) The auto-sensing output of the IOTA ILB-CP Series will automatically adjust to the output voltage within that range. Also, confirm that the emergency driver will not exceed the power specifications (voltage and current) of the normal driver.

Calculate Lumen Output

Multiply the ILB-CP's wattage with your luminaire's verified published efficacy (lumens per watt) to calculate your emergency lumen output. Verified efficacy performance for many luminaires can be found on the manufacturer's specification sheets or at the DesignLights Consortium website (www.designlights.org) or the Lighting Facts website (www.lightingfacts.com). Always make sure the lumen package you select adequately delivers the desired means-of-egress lighting for your project.



The ILB-CP Series Specifier's Toolkit

Visit www.iotaengineering.com/cptools for on-line resources that can assist in selecting and specifying the ILB-CP product for your application requirements. Our **ILB-CP Performance Calculator** will easily provide the operating current and lumen output for your LED luminaire system, and our on-line sample specifications provide simple Copy and Paste specs for use in your project documentation.

ILB-CP Series Compatibility and Suitability of Use

While accessing the ILB-CP Toolkit, be sure to reference the *Compatibility and Suitability of Use* Guidelines when specifying IOTA ILB-CP LED emergency drivers for field installation.

Need further assistance? You can always give our Customer Service team a call at 1-800-866-4682.



ILB-CP Mounting and Wiring

Mounting Configurations (Standard)

IOTA **ILB-CP** Emergency Drivers are available in a variety of wattage and mounting configurations. When specifying the ILB-CP unit for your project, add the desired wattage and mounting suffix to the ILB-CP model number.

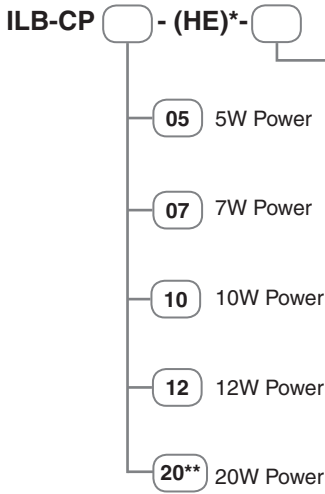

*Insert "HE" if high-efficiency model is applicable. Note that "HE" is available in select wattages only (see page 10.)

**Available in "-A," "-R," and "-S" configurations only.

Mounting Accessories

A selection of mounting accessories is available for meeting individual installation requirements. Refer to Page 49 for mounting accessory options.



A

Dual Flex

Provides dual flex for wiring to both the fixture or driver compartment and test accessories.

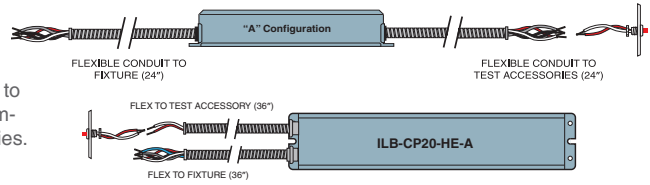

B

Integral Non-Flex

Allows for integral installation within the driver compartment. May also be mounted atop the fixture when used with a TMK cover accessory.



J

Single Flex Junction Box Mount

Mounts to the junction box and provides flexible conduit for remote mounting of the test accessories.

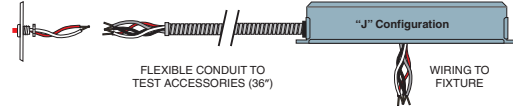

R

Dual Flex w/ Reflector-Mount TBTS

Provides dual flex for wiring to the fixture. The TBTS test accessory hardware installs directly within the reflector. (Recommended for OEM installation only.)

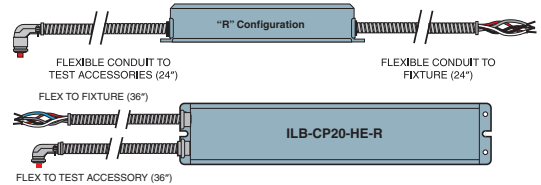

R-J

Single Flex w/ Reflector-Mount TBTS

Mounts to the junction box. The TBTS test accessory hardware installs directly within the reflector. (Recommended for OEM installation only.)

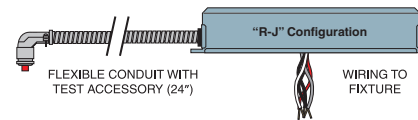

S

Single Flex (20W unit only)

Single conduit that routes all wiring directly to the fixture channel space or junction box.



TM

Top-Mount Non-Flex

Top-mounting option for running wires directly into the driver compartment. Test accessories are then installed within the fixture.

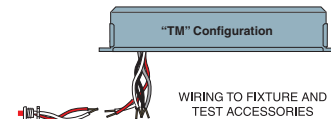

XB

Integral Non-Flex with Push-In Connectors

The XB provides an integral no-flex design with integrated push-in ports for quicker connection to the LED array, test components, and AC power inputs.

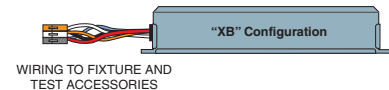

Use the XB Harness for Simplified, Faster Installation!

The new "-XB" harness configuration simplifies the installation process and reduces the chances of wiring issues by providing pre-configured push-in connectors that allow quick and easy connection of the LED array, the test switch/charge indicator components, and the AC switched, unswitched, and neutral inputs. Since the ILB-CP Emergency Driver Series is compatible with a wide variety of LED driver designs, the XB harness delivers a simple emergency option for your Normal Driver selection!

- Exceptional Performance
- Expedient Installation
- Extra-Easy!

XB Configuration is available on select ILB-CP emergency driver models.

Mounting Configurations (Low Profile)

IOTA ILB-LP-CP Emergency Drivers feature a low profile lithium battery design offered in a variety of minimal footprint enclosure sizes. **CA Title 20 performance (HE)** and **Self-Diagnostic features (SD)** are standard for IOTA ILB-LP-CP units.

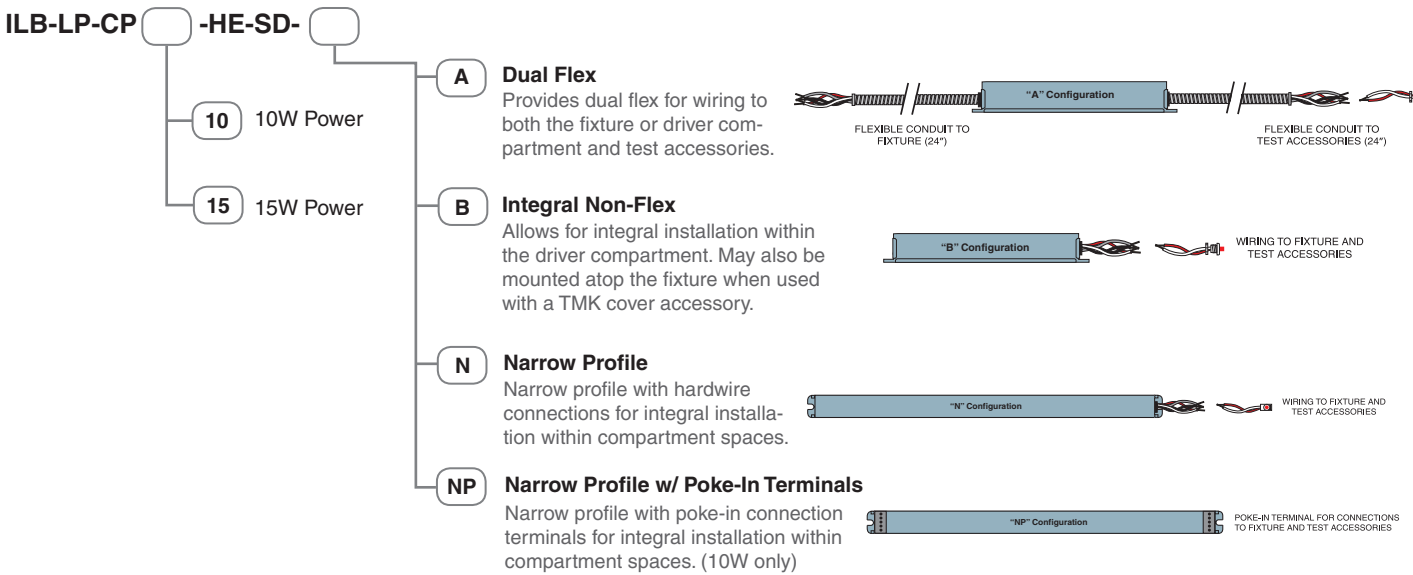

Mounting Configurations (Slim Profile)

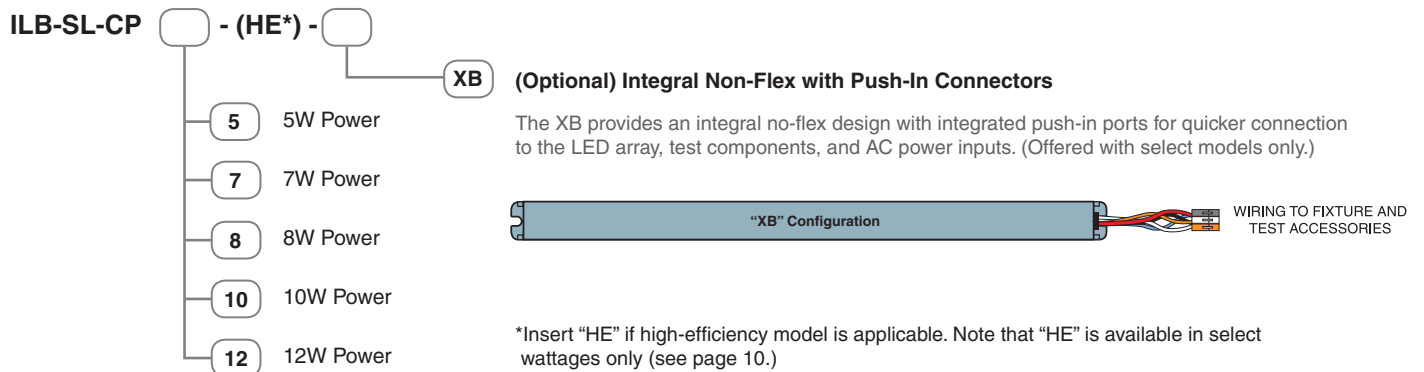

Wiring

The ILB-CP unit electrically exists between the normal AC driver and LED load. The emergency unit supplies power to the LED array when normal power is lost to the AC driver.

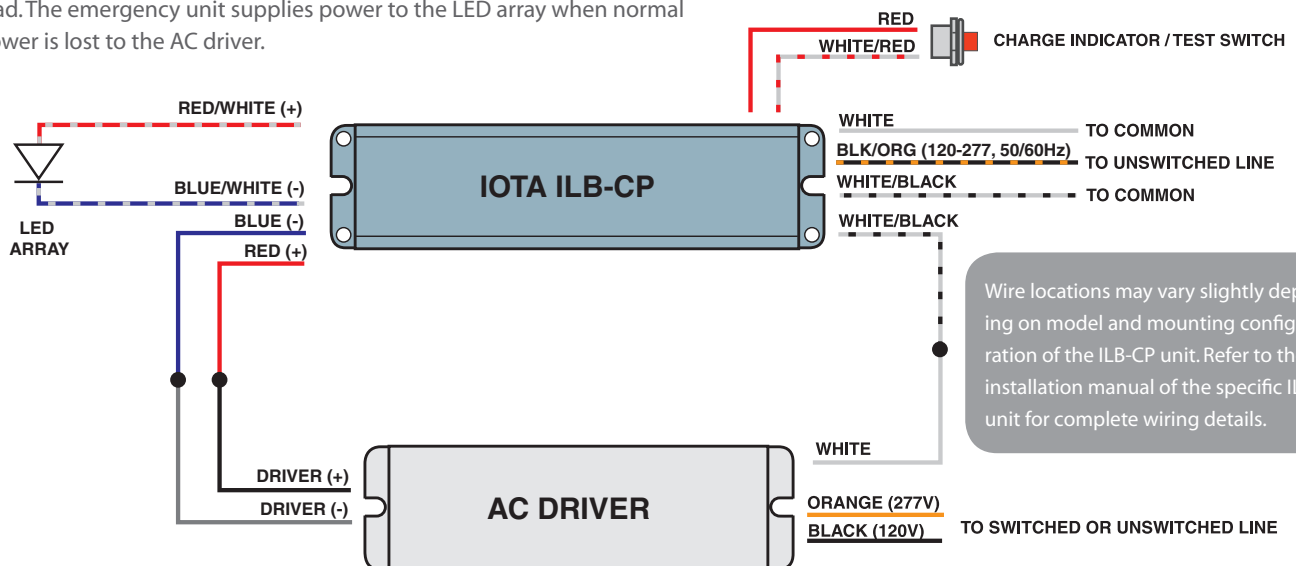



Emergency Ballasts

for LED Retrofit and Fluorescent



IOTA emergency ballasts keep pace with evolving lighting technology to deliver confident emergency solutions for today's environmentally-friendly fluorescent lamp designs as well as state-of-the-art LED retrofit tube models.



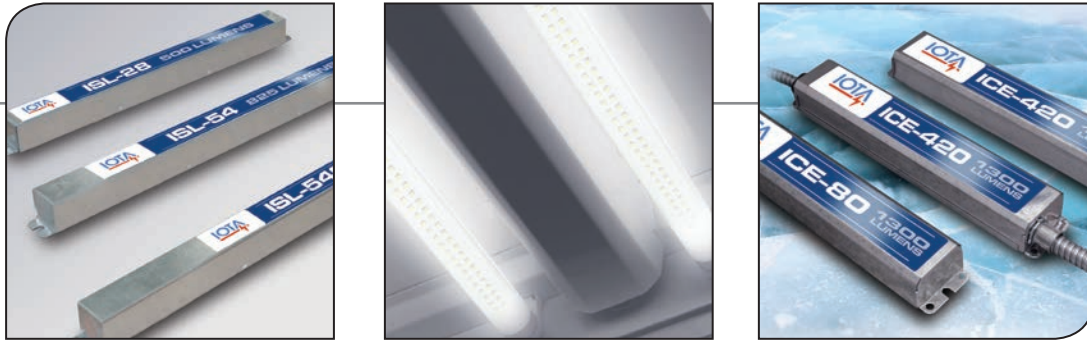

- **LED Retrofit Solutions with AC Output**
Select IOTA emergency ballasts feature AC output, making them ideally suited for operating low-mercury content amalgam fluorescents and many LED retrofit tube replacements types.
- **Linear and Compact Lamp Compatibility**
IOTA offers a full line of emergency ballast solutions for operating T5 through T8 linear lamps and 2-pin or 4-pin compact lamps and a full range of lamp lengths and wattages.
- **Lumen and Application Options**
IOTA emergency ballasts can provide illumination from 500 to 3000 lumens and meet unique fixture and installation needs such as damp location, enclosed and gasketed fixtures, cold-weather applications, parallel operation, and self-diagnostic requirements.
- **Time Delay and Open Circuit Isolation**
IOTA emergency ballasts utilize enhanced protection features for optimal performance with the latest AC ballast technology. Time Delay and Open Circuit Isolation allows the emergency ballast to operate seamlessly with 'end-of-life' and lamp removal safeguards.
- **RoHS Compliant**
IOTA emergency ballasts are responsibly designed and manufactured to RoHS standards for minimal environmental impact.



LED Retrofit Technology is a popular way to bring the benefits of LED energy savings to your existing fluorescent fixtures. IOTA provides solutions for three common types of LED retrofit options - A) LED Tube Lamps, B) LED Tube Lamps with Internal Drivers and C) LED Retrofit Kits. These solutions will enable you to make a seamless transition to modern LED lighting while maintaining your emergency egress requirements. For further details on all of IOTA's LED Retrofit Solutions, visit our on-line resources at www.iotaengineering.com/retrofit.

A LED Tube Lamps (T-LEDs)

LED Tube Lamps are linear, compact, or U-bent LED lights, also known as T-LEDs, which directly replace the fluorescent tubes in your fixture. These T-LED lamps are designed to convert the AC voltage coming from your fluorescent ballast to DC current to operate the lamp's LED arrays. These T-LED designs allow you to simply replace the fluorescent tube with the LED lamp without removing or re-wiring the existing AC ballast.

IOTA Emergency Solution - IOTA Ballasts with AC Output

LED Tube Lamp retrofit technology limits the use of existing fluorescent emergency ballasts due to the fact that some emergency ballasts provide only DC current to the lamp load. Therefore, it is important that your emergency battery pack be capable of providing **true AC output** to your T-LEDs (see Fig. 1).

IOTA Engineering offers several different emergency ballasts that are capable of providing true AC output. All of these emergency ballasts have been tested and are **UL Listed** to work with select T-LEDs from major LED tube manufacturers. See the chart below for details on available AC output IOTA Emergency Ballast options.

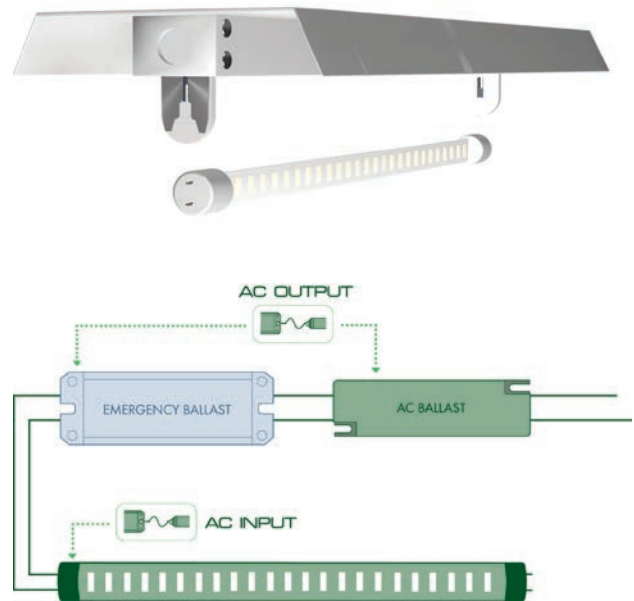

Fig.1 - The LED tube lamp that would typically accept the AC output of a normal AC ballast will function with an emergency ballast that also provides AC output.

The Importance of UL Testing



A UL 924 Listing indicates that the product meets the necessary performance requirements for use as emergency lighting equipment *when used in conjunction with specific lamp types*. In order to meet Life Safety standards, the product must achieve predetermined ft-candles for at least 90 minutes (see Page 50 for more details.) Switching the lamp from an 'analog' fluorescent lamp to 'digital' LED technology can dramatically affect the load characteristics that the emergency ballast is designed for. While initially an emergency ballast can appear to operate the lamp, the lumen performance and operating duration may not meet the Life Safety parameters. For this reason, IOTA verifies compatibility and includes the tested LED lamp in the UL Listing.

New tube lamp options are continually being tested and evaluated for compatibility and compliance with Life Safety requirements. To see the current list of compatible tube lamp options, visit our LED Retrofit Solutions guide at www.iotaengineering.com/retrofit. If you are an LED tube lamp manufacturer and would like to submit a lamp for evaluation, contact our Technical Services Team at 1-855-363-9527.

B LED Tube Lamps (T-LEDs) with Internal Drivers

LED Tube Lamps with Internal Drivers (may include downlight retrofit kits or linear LED lamps) feature built-in drivers that accept AC *line voltage* and allow you to replace both your existing fluorescent lamps *and* fluorescent ballast to convert your fixture to LED.

IOTA Emergency Solution - IIS Series Inverters

Since these LED Lamps are wired directly to the line voltage, an emergency battery pack cannot be introduced between the driver and the lamp. Therefore your emergency lighting solution must deliver line voltage to the LED lamps from an auxiliary supply. This can be done with a generator or an IOTA IIS Series emergency Inverter (Figure 2). A single IIS Inverter will be capable of running multiple fixtures, regardless of whether they are using LED retrofit lamps or traditional fluorescent tubes. For further details on IOTA IIS Inverter options, refer to Page 36.



Fig.2 - LED tube lamps with internal drivers do not require a fluorescent ballast. When no external ballast is available to wire the emergency ballast to, an auxiliary supply such as a generator or inverter must be used to provide emergency line power.

C LED Retrofit Kits

LED Retrofit Kits include LED tubes or board arrays paired to an LED Driver. The LED lamps and LED driver take the place of your fluorescent lamps and your fluorescent ballast within your existing fluorescent fixture.

IOTA Emergency Solution - ILB-CP Emergency Drivers

When completely replacing the fluorescent technology with LED technology in these retrofit fixtures, the emergency lighting solution of choice is an **emergency LED driver suitable for field installation**. The emergency LED driver installs between the normal LED driver and LED tubes or arrays provided in the kit, and will operate the LEDs during a power loss situation.

Many LED emergency drivers on the market today are UL Recognized Components for factory installation only and therefore are not typically acceptable for retrofit installation. **IOTA ILB-CP LED Emergency Drivers** are **UL Listed for field installation**, are fully compatible with retrofit installations, and offer a full line of wattage and mounting styles. Full ILB-CP Series details can be found on Page 6.



Learn more about LED Retrofit on YouTube...

Our popular LED Retrofit Video is a useful resource to understanding the nature of LED retrofit options and emergency requirements. You can find the video on our IOTA YouTube Channel or visit www.iotaengineering.com/retrofit.



SCAN TO WATCH!

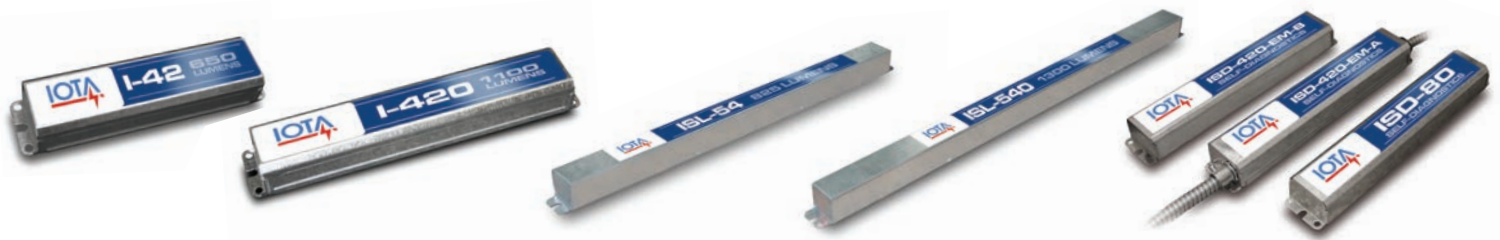

I-42

650 LUMENS

Input Voltage
Dual 120/277VAC, 60Hz

Input Wattage
3.5 Watts

Emergency Operation
90 minutes

Initial Illumination
1 lamp up to 650 lumens

Operating Temp
0° to 50° C

Battery
High-Temp Ni-Cad
24 Hour Recharge
7-10 Year Life Expectancy

Weight
4.4 lbs (dual flex)
2.5 lbs (no flex)

Approval
UL Listed for U.S.
and Canada.



Suitable for damp location, plenum, and enclosed and gasketed fixtures.

Dimensions
9.5" x 2.4" x 1.5"
(mounting center 9.0")

Both the I-42 and I-420 offer mounting configuration options to match the requirements of your fixture design. Refer to Page 34 for descriptions of the different mounting style offerings.

Mounting Versatility

I-420

1100 LUMENS

Input Voltage
Dual 120/277VAC, 60Hz

Input Wattage
3.5 Watts

Emergency Operation
90 minutes

Initial Illumination
1 lamp up to 1100 lumens

Operating Temp
0° to 50° C

Battery
High-Temp Ni-Cad
24 Hour Recharge
7-10 Year Life Expectancy

Weight
5.4 lbs (dual flex)
3.5 lbs (no flex)

Approval
UL Listed for U.S.
and Canada.



Suitable for damp location, plenum, and enclosed and gasketed fixtures.

Dimensions
13.3" x 2.4" x 1.5"
(mounting center 12.75")

ISL-54

825 LUMENS

Input Voltage
Dual 120/277VAC, 60Hz

Input Wattage
2.5 Watts

Emergency Operation
90 minutes

Initial Illumination
1 lamp up to 825 lumens

Operating Temp
0° to 50° C

Battery
High-Temp Ni-Cad
24 Hour Recharge
7-10 Year Life Expectancy

Weight
2.4 lbs.

Approval
UL Listed for U.S.
and Canada.



Suitable for damp location, plenum, and enclosed and gasketed fixtures.

Dimensions
17.5" x 1.18" x 1.15"
(mounting center 17.0")

The IOTA ISL Series Emergency Ballasts feature a slim 1.2" x 1.2" profile design that makes them ideal for narrow troffer designs with limited compartment space.

Slim Profile

ISL-540

1300 LUMENS

Input Voltage
Dual 120/277VAC, 60Hz

Input Wattage
3.5 Watts

Emergency Operation
90 minutes

Initial Illumination
1 lamp up to 1300 lumens

Operating Temp
0° to 50° C

Battery
High-Temp Ni-Cad
24 Hour Recharge
7-10 Year Life Expectancy

Weight
3.0 lbs.

Approval
UL Listed for U.S.
and Canada.



Suitable for damp location, plenum, and enclosed and gasketed fixtures.

Dimensions
21.5" x 1.18" x 1.15"
(mounting center 21.0")

ISD Series

1100 LUMENS

Input Voltage
Universal 110-277VAC, 50/60Hz

Input Wattage
5 Watts (max)

Power Factor
≥ 0.9

Emergency Operation
90 minutes

Initial Illumination
1 lamp up to 1100 lumens

Operating Temp
0° to 55° C

THD
< 20%

Battery
High-Temp Ni-Cad
24 Hour Recharge
7-10 Year Life Expectancy

Weight
4.4 lbs (dual flex)
2.5 lbs (no flex)

Approval
UL Listed for U.S.
and Canada.

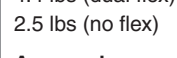

Suitable for damp location, plenum, and enclosed and gasketed fixtures.

Dimensions
13.3" x 2.4" x 1.5"
(mounting center 12.75")

IOTA's ISD Series provides automatic monthly and annual testing of the ballast and lamp. Integral (ISD-80) and Flexed (ISD-420-EM-A) models available.

Self-Diagnostic Capability





LED RETROFIT SOLUTIONS

I-320

1350 LUMENS

Input Voltage
Dual 120/277VAC, 60Hz

Input Wattage
3.5 Watts

Emergency Operation
90 minutes

Initial Illumination
1 lamp up to 1350 lumens

Operating Temp
0° to 50° C

Battery
High-Temp Ni-Cad
24 Hour Recharge
7-10 Year Life Expectancy

Weight
2.5 lbs

Approval
UL Listed for U.S.
and Canada



Suitable for damp location, plenum, and enclosed and gasketed fixtures.

Dimensions
13.0" x 2.2" x 1.25"
(mounting center 12.6")

The 1.25" reduced profile of the I-320 allows the unit to strike a popular balance of lumen output performance and effective fit for shallow compartment spaces.

Reduced Profile

I-320-HE

1350 LUMENS

Input Voltage (Universal)
120-277VAC, 50/60Hz

Input Wattage
3.7 Watts

Power Factor
≥ 0.9 @ 120Vac
≥ 0.85 @ 277Vac

Emergency Operation
90 minutes

Initial Illumination
(1) Lamp up to 1350 lumens

Operating Temp
0° to 55° C

Battery
High-Temp Ni-Cad
24 Hour Recharge
7-10 Year Life Expectancy

Weight
3.0 lbs
3.0 lbs

Approval
UL Listed for United States



California Title 20
Suitable for damp location, plenum, and enclosed and gasketed fixtures.

Dimensions
16.35" x 2.3" x 1.2"
(mounting center 16.0" x 1.57")

The I-320-HE combines the reduced profile of the I-320 with High-Efficiency micro-processor performance for California Title 20 applications. Dual-Flex model also available.

Meets CA Title 20

I-160

3000 LUMENS

Input Voltage
Dual 120/277VAC, 60Hz

Input Wattage
4.5 Watts

Emergency Operation
90 minutes

Initial Illumination
Up to 3000 lumens

Operating Temp
0° to 50° C

Battery
High-Temp Ni-Cad
24 Hour Recharge
7-10 Year Life Expectancy

Weight
7.5 lbs

Approval
UL Listed for U.S.
and Canada



Suitable for damp location and plenum fixtures.

Dimensions
16.375" x 3.0" x 3.0"
(mounting center 15.875")

The increased battery capacity of the I-160 maximizes lumen output for high bay and elevated ceiling applications.

Maximum Output

I-162

3000 LUMENS

Input Voltage
Dual 120/277VAC, 60Hz

Input Wattage
4.5 Watts

Emergency Operation
90 minutes

Initial Illumination
Up to 3000 lumens

Operating Temp
0° to 50° C

Battery
High-Temp Ni-Cad
24 Hour Recharge
7-10 Year Life Expectancy

Weight
7.5 lbs

Approval
UL Listed for U.S.
and Canada



Suitable for damp location and plenum fixtures.

Dimensions
16.375" x 3.0" x 3.0"
(mounting center 15.875")

The parallel operation feature of the I-162 will operate two lamps running in series. If one lamp is inoperable, the I-162 will power the remaining lamp.

Parallel Operation

NEW! I-4PT-A

400 LUMENS

Input Voltage (Universal)
120-277VAC, 50/60Hz

Input Wattage
20mA (max)

Emergency Operation
90 minutes

Initial Illumination
250-400 lumens

Operating Temp
0° to 55° C

Battery
High-Temp Ni-Cad
24 Hour Recharge
7-10 Year Life Expectancy

Weight
3.5 lbs

Approval
UL Listed for U.S.
and Canada



California Title 20
Suitable for damp location and plenum fixtures.

Dimensions
9.5" x 2.4" x 1.5"
(mounting center 9.0")

Meets CA Title 20

Specialized T-LED Design

The IOTA I-4PT-A is specifically engineered to deliver emergency power to today's 4-pin LED retrofit lamps. The I-4PT-A combines a compact enclosure and dual-flex design with high-efficiency control for meeting CEC Title 20 requirements.



Linear Lamp Emergency Ballasts



IOTA's linear fluorescent products provide practical solutions for most linear lamp type fixtures utilizing 2-ft to 8-ft T5 through T12 lamps.

I-32

500 LUMENS

Input Voltage

Dual 120/277VAC, 60Hz

Input Wattage

2.5 Watts

Lamps Operated

Most 2'-4' single, bipin T8 thru T12 and 28W T5 fluorescent lamps

Emergency Operation

(1) 2'-4' lamp
90 minutes

Initial Illumination

(1) Lamp up to 500 lumens

Operating Temp

0° to 50° C

Battery

High-Temp Nickel-Cadmium
24 Hour Recharge
7-10 Year Life Expectancy

Weight

1.5 lbs

Approval

UL Listed for U.S. & Canada.



Rated for plenum and enclosed & gasketed fixtures.

Dimensions

9.5" x 2.0" x 1.0"
(mounting center 9.0")

I-40

700 LUMENS

Input Voltage

Dual 120/277VAC, 60Hz

Input Wattage

3.5 Watts

Lamps Operated

Most 2'-4' single, bipin T8-T12, fluorescent lamps & 40W long compacts

Emergency Operation

(1) 2'-4' lamp
90 minutes

Initial Illumination

(1) Lamp up to 700 lumens

Operating Temp

0° to 50° C

Battery

High-Temp Nickel-Cadmium
24 Hour Recharge
7-10 Year Life Expectancy

Weight

2.4 lbs

Approval

UL Listed for U.S. & Canada.



Rated for damp location, plenum, and enclosed & gasketed fixtures.

Dimensions

9.5" x 2.4" x 1.5"
(mounting center 9.0")

I-48

700 LUMENS

Input Voltage

Dual 120/277VAC, 60Hz

Input Wattage

3.5 Watts

Lamps Operated

Most 2'-8' single, bipin T8 thru T12, HO, VHO fluorescent lamps incl. long compacts

Emergency Operation

(1) 2'-8' or (2) 2'-4' lamps*
90 minutes

Initial Illumination

(1) Lamp up to 700 lumens
(2) Lamps up to 350 lumens ea.

Operating Temp

0° to 50° C

Battery

High-Temp Nickel-Cadmium
24 Hour Recharge
7-10 Year Life Expectancy

Weight

2.4 lbs

Approval

UL Listed for U.S. & Canada.



Rated for damp location, plenum, and enclosed & gasketed fixtures.

Dimensions

9.5" x 2.4" x 1.5"
(mounting center 9.0")

*Long Compacts - 1 lamp only

I-320

1350 LUMENS

Input Voltage

Dual 120/277VAC, 60Hz

Input Wattage

3.5 Watts

Lamps Operated

Most 2'-4' single, bipin T8, 2'-4' 14W-54W T5, HO and VHO fluorescent lamps

Emergency Operation

(1) 2'-4' lamp
90 minutes

Initial Illumination

(1) Lamp up to 1350 lumens

Operating Temp

0° to 50° C

Battery

High-Temp Nickel-Cadmium
24 Hour Recharge
7-10 Year Life Expectancy

Weight

2.5 lbs

Approval

UL Listed for U.S. & Canada.



Rated for damp location, plenum, and enclosed & gasketed fixtures.

Dimensions

13.0" x 2.2" x 1.25"
(mounting center 12.6")

LED Retrofit Solution

I-320-HE

1350 LUMENS

Input Voltage (Universal)

120-277VAC, 50/60Hz

Input Wattage

3.7 Watts

Lamps Operated

Most 2'-4' single, bipin T8, 2'-4' 14W-54W T5, HO and VHO fluorescent lamps

Power Factor

≥ 0.9 @ 120Vac
≥ 0.85 @ 277Vac

Emergency Operation

(1) 2'-4' lamp - 90 minutes

Initial Illumination

(1) Lamp up to 1350 lumens

Operating Temp

0° to 55° C

Battery

High-Temp Nickel-Cadmium
24 Hour Recharge
7-10 Year Life Expectancy

Weight

3.0 lbs

Approval

UL Listed for United States



California Title 20

Rated for damp location, plenum, and enclosed & gasketed fixtures.

Dimensions

16.35" x 2.3" x 1.2"
(mounting center 16.0" x 1.57")

LED Retrofit Solution

BC Meets CA Title 20

Designed for Superior Performance

IOTA Emergency Lighting Products are engineered and manufactured for reliable performance in your egress applications...see Page 35 for more product details.

- Versatile mounting designs
- Single-piece test switch and charge indicator
- Rated for damp location and enclosed & gasketed fixtures
- Galvanized steel construction
- RoHS compliant
- 5-Year Warranty



Increased emergency illumination and additional safety features are beneficial assets to projects such as municipal facilities, retirement communities, schools, and daycares. These IOTA units deliver unique advantages to these types of critical applications.



I-880

2000 LUMENS

Input Voltage

Dual 120/277VAC, 60Hz

Input Wattage

4.5 Watts

Lamps Operated

Most 2'-8' single, bipin T8 thru T12, HO & VHO fluorescent lamps incl. long compacts, 2'-4' 28W & 54W T5

Emergency Operation

(1) 2'-8' or (2) 2'-4' lamps*
90 minutes

Initial Illumination

(1) Lamp - 2000 lumens
(2) Lamps - 1000 lumens each

Operating Temp

0° to 50° C

Battery

High-Temp Nickel-Cadmium
24 Hour Recharge
7-10 Year Life Expectancy

Weight

4.4 lbs

Approval

UL Listed for U.S. and Canada.



Suitable for plenum fixtures.

Integral Profile Dimensions

18.6" x 2.4" x 1.5"
(mounting center 18.1")

*Long Compacts - 1 lamp only

I-160

3000 LUMENS

Input Voltage

Dual 120/277VAC, 60Hz

Input Wattage

4.5 Watts

Lamps Operated

Most 2'-4' single, bipin T8 and T5 and 18 to 70W 4-pin compact fluorescent lamps

Emergency Operation

(1) 2'-4' lamp, (2) 17W T8, 26W 4-pin
90 minutes

Initial Illumination

(1) Lamp - 3000 lumens
(2) Lamps - 1500 lumens each

Operating Temp

0° to 50° C

Battery

High-Temp Nickel-Cadmium
24 Hour Recharge
7-10 Year Life Expectancy

Weight

7.5 lbs

Approval

UL Listed for U.S. and Canada.



Suitable for damp location and plenum fixtures.

Dimensions

16.375" x 3.0" x 3.0"
(mounting center 15.875")

LED Retrofit Solution

I-232

1400 LUMENS

Input Voltage

Dual 120/277VAC, 60Hz

Input Wattage

4 Watts

Lamps Operated

(2) 2'-4' single, bipin T8 thru T12 HO and VHO fluorescent lamps **in parallel**

Emergency Operation

(2) 2'-4' lamp
90 minutes

Initial Illumination

(2) Lamps - 1400 lumens
700 lumens each

Operating Temp

0° to 50° C

Battery

High-Temp Nickel-Cadmium
24 Hour Recharge
7-10 Year Life Expectancy

Weight

3.6 lbs

Approval

UL Listed for U.S. and Canada.



Suitable for damp location, plenum, and enclosed and gasketed fixtures.

Dimensions

13.3" x 2.4" x 1.5"
(mounting center 12.75")

Parallel Operation

I-162

3000 LUMENS

Input Voltage

Dual 120/277VAC, 60Hz

Input Wattage

4.5 Watts

Lamps Operated

(2) 2'-4' single, bipin T8 thru T12, 28W & 54W T5, 24W-50W long compacts **in parallel**

Emergency Operation

(2) 2'-4' lamp
90 minutes

Initial Illumination

(2) Lamps - 3000 lumens
1500 lumens each

Operating Temp

0° to 50° C

Battery

High-Temp Nickel-Cadmium
24 Hour Recharge
7-10 Year Life Expectancy

Weight

7.5 lbs

Approval

UL Listed for U.S. and Canada.



Suitable for damp location and plenum fixtures.

Dimensions

16.375" x 3.0" x 3.0"
(mounting center 15.875")

LED Retrofit Solution

Parallel Operation

FLUORESCENT & LED RETROFIT



High-Efficiency Design

The I-320-HE features a unique micro-processor design that maintains the emergency battery fully while also minimizing power consumption in the standby mode. IOTA "HE" products meet CEC energy requirements for the State of California.



LED Retrofit Solution

The AC Output design provides compatibility with many LED retrofit tube lamps as well as proper operation of environmentally-friendly low-mercury content amalgam fluorescents. See page 22 for LED compatibility details.



Parallel Operation

Parallel Operation design operates two lamps in parallel in the emergency mode. If one of the lamps is inoperable, the emergency ballast will continue to operate the remaining lamp.



Compact 4-Pin

With AC output and different mounting options, IOTA emergency ballasts for compact lamps provide versatile solutions for 4-pin downlight lamp and fixture applications.

I-42

650 LUMENS

Input Voltage

Dual 120/277VAC, 60Hz

Input Wattage

3.5 Watts

Lamps Operated

10W-42W 4-Pin Rapid Start Twin, Triple, Quad Tube, 2D, Straight Compacts & 18-36W Long Compacts

Emergency Operation*

(1) 10W-42W or (2) 10W-18W
90 minutes

Initial Illumination

(1) lamp 650 lumens
(2) lamps 325 lumens each

Operating Temp

0° to 50° C

Battery

High-Temp Nickel-Cadmium
24 Hour Recharge
7-10 Year Life Expectancy

Weight

4.4 lbs (dual flex)
2.5 lbs (no flex)

Approval

UL Listed for U.S. and Canada.



Suitable for damp location, plenum, and enclosed and gasketed fixtures.

Dimensions

9.5" x 2.4" x 1.5"
(mounting center 9.0")

LED Retrofit Solution

*Long Compacts - 1 lamp only

I-42-L

650 LUMENS

Input Voltage

Dual 120/277VAC, 60Hz

Input Wattage

3.5 Watts

Lamps Operated

10W-42W 4-Pin Rapid Start Twin, Triple, Quad Tube, 2D, Straight Compacts & 18-36W Long Compacts

Emergency Operation*

(1) 10W-42W or (2) 10W-18W
90 minutes

Initial Illumination

(1) lamp 650 lumens
(2) lamps 325 lumens each

Operating Temp

0° to 50° C

Battery

High-Temp Nickel-Cadmium
24 Hour Recharge
7-10 Year Life Expectancy

Weight

2.5 lbs

Approval

UL Component Recognized for Factory Installation.



Dimensions

Circuit board: 4.0" x 2.75" x 1.25"
Battery: (Refer to Page 29 sidebar)

Open Board Design

I-420

1100 LUMENS

Input Voltage

Dual 120/277VAC, 60Hz

Input Wattage

3.5 Watts

Lamps Operated

10W-57W 4-Pin Rapid Start Twin, Triple, Quad Tube, 2D, Straight Compact Lamps

Emergency Operation

(1) 10W-57W or (2) 10W-26W
90 minutes

Initial Illumination

(1) lamp 1100 lumens
(2) lamps 550 lumens each

Operating Temp

0° to 50° C

Battery

High-Temp Nickel-Cadmium
24 Hour Recharge
7-10 Year Life Expectancy

Weight

5.4 lbs (dual flex)
3.5 lbs (no flex)

Approval

UL Listed for U.S. and Canada.



Suitable for damp location, plenum, and enclosed and gasketed fixtures.

Dimensions

13.3" x 2.4" x 1.5"
(mounting center 12.75")

LED Retrofit Solution

I-320-HE-A

1350 LUMENS

Input Voltage (Universal)

120-277VAC, 50/60Hz

Input Wattage

3.7 Watts

Lamps Operated

13W-42W 4-Pin Rapid Start Twin, Triple, Quad Tube, 2D, Straight Compact Lamps

Power Factor

≥ 0.9 @ 120Vac
≥ 0.85 @ 277Vac

Emergency Operation

(1) lamp - 90 minutes

Initial Illumination

(1) Lamp up to 1350 lumens

Operating Temp

0° to 55° C

Battery

High-Temp Nickel-Cadmium
24 Hour Recharge
7-10 Year Life Expectancy

Weight

3.5 lbs (dual flex)

Approval

UL Listed for United States



California Title 20

Rated for damp location and plenum fixtures.

Dimensions

16.35" x 2.3" x 1.2"
(mounting center 16.0" x 1.57")

LED Retrofit Solution



Certified CA Title 20



Designed for Superior Performance

IOTA Emergency Lighting Products are engineered and manufactured for reliable performance in your egress applications...see Page 35 for more product details.

- Versatile mounting designs
- Single-piece test switch and charge indicator
- Rated for damp location and enclosed & gasketed fixtures
- Galvanized steel construction
- RoHS compliant
- 5-Year Warranty

Compact 2-Pin

The IOTA I-13 and I-26 emergency ballasts are specifically designed to operate 2-pin compact lamps from 7W to 26W and feature a two-piece test switch and charge indicator accessory kit.



I-26

650 LUMENS

Input Voltage

Dual 120/277VAC, 60Hz

Input Wattage

3.5 Watts

Lamps Operated

18W-26W Quad Tube 2-Pin compact lamps with integral starter

Emergency Operation

(1) lamp
90 minutes

Initial Illumination

(1) lamp up to 650 lumens

Operating Temp

0° to 50° C

Battery

High-Temp Nickel-Cadmium
24 Hour Recharge
7-10 Year Life Expectancy

Weight

4.4 lbs (dual flex), 2.5 lbs (no flex)

Approval

UL Listed for U.S. and Canada.
Rated for damp location, plenum, and enclosed & gasketed fixtures.



Dimensions

9.5" x 2.4" x 1.5"
(mounting center 9.0")

I-13

650 LUMENS

Input Voltage

Dual 120/277VAC, 60Hz

Input Wattage

3.5 Watts

Lamps Operated

7,9,13 Watt Twin Tube 2-Pin & 9W-13 Watt Quad 2-Pin lamps with integral starter

Emergency Operation

(1) lamp
90 minutes

Initial Illumination

(1) lamp up to 650 lumens

Operating Temp

0° to 50° C

Battery

High-Temp Nickel-Cadmium
24 Hour Recharge
7-10 Year Life Expectancy

Weight

4.4 lbs (dual flex), 2.5 lbs (no flex)

Approval

UL Listed for U.S. and Canada.
Rated for damp location, plenum, and enclosed & gasketed fixtures.



Dimensions

9.5" x 2.4" x 1.5"
(mounting center 9.0")

I-13-L

650 LUMENS OPEN BOARD

Input Voltage

Dual 120/277VAC, 60Hz

Input Wattage

3.5 Watts

Lamps Operated

7,9,13 Watt Twin Tube 2-Pin & 9W-13 Watt Quad 2-Pin lamps with integral starter

Emergency Operation

(1) lamp
90 minutes

Initial Illumination

(1) lamp up to 650 lumens

Operating Temp

0° to 50° C

Battery

High-Temp Nickel-Cadmium
24 Hour Recharge
7-10 Year Life Expectancy

Weight

2.5 lbs

Approval

UL Component Recognized for Factory Installation.



Dimensions

Circuit board: 4.0" x 2.75" x 1.25"
Battery: (Refer to sidebar)

Battery Profiles

The 3-cell battery for open board designs is available in three configurations:

Triangle

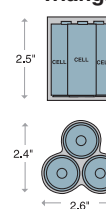

In-Line

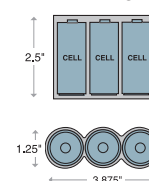

Stick

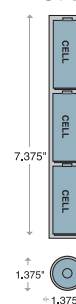

Open Board Design



LED Retrofit Solution

The AC Output design provides compatibility with many LED retrofit tube lamps as well as proper operation of environmentally-friendly low-mercury content amalgam fluorescents. See page 22 for LED compatibility details.



Parallel Operation

Parallel Operation design operates two lamps in parallel in the emergency mode. If one of the lamps is inoperable, the emergency ballast will continue to operate the remaining lamp.

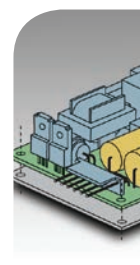

Open Board Designs

Open board emergency ballast kits provide versatility for OEM fixture installations. Includes the charger and inverter circuit board with separate battery. UL Recognized Component only. Refer to the sidebar above for battery options.



Slim Profile

IOTA's "ISL" emergency ballasts feature a slim profile enclosure for installation in fixture designs with limited compartment space.

ISL-28

500 LUMENS

Input Voltage

Dual 120/277VAC, 60Hz

Input Wattage

2.5 Watts

Lamps Operated

Most 2'-4' 28W T5 and T8 linear fluorescent lamps

Emergency Operation

(1) lamp
90 minutes

Initial Illumination

(1) lamp up to 500 lumens

Operating Temp

0° to 50° C

Battery

High-Temp Nickel-Cadmium
24 Hour Recharge
7-10 Year Life Expectancy

Weight

2.0 lbs.

Approval

UL Listed for U.S. and Canada.
Rated for damp location, plenum, and enclosed and gasketed fixtures.

Dimensions

14.2" x 1.18" x 1.15"
(mounting center 13.7")

ISL-54

825 LUMENS

Input Voltage

Dual 120/277VAC, 60Hz

Input Wattage

2.5 Watts

Lamps Operated

Most 2'-4' 14W to 54W T5 or 17W to 30W T6 and T8 lamps including HO and 36W-55W 4-pin long compact lamps

Emergency Operation

(1) lamp
90 minutes

Initial Illumination

(1) lamp up to 825 lumens

Operating Temp

0° to 50° C

Battery

High-Temp Nickel-Cadmium
24 Hour Recharge
7-10 Year Life Expectancy

Weight

2.4 lbs.

Approval

UL Listed for U.S. and Canada.
Rated for damp location, plenum, and enclosed & gasketed fixtures.

Dimensions

17.5" x 1.18" x 1.15"
(mounting center 17.0")

LED Retrofit Solution

ISL-540

1300 LUMENS

Input Voltage

Dual 120/277VAC, 60Hz

Input Wattage

3.5 Watts

Lamps Operated

Most 2'-4' 14W to 54W T5 or 17W to 40W T8 lamps including HO and 36W-55W 4-pin long compact lamps.*

Emergency Operation

(1) lamp
90 minutes

Initial Illumination

(1) lamp up to 1300 lumens

Operating Temp

0° to 50° C

Battery

High-Temp Nickel-Cadmium
24 Hour Recharge
7-10 Year Life Expectancy

Weight

3.0 lbs.

Approval

UL Listed for U.S. and Canada.
Rated for damp location, plenum, and enclosed & gasketed fixtures.

Dimensions

21.5" x 1.18" x 1.15"
(mounting center 21.0")

LED Retrofit Solution

*Modification available for 54W lamps



Designed for Superior Performance

IOTA Emergency Lighting Products are engineered and manufactured for reliable performance in your egress applications...see Page 35 for more product details.

- Versatile mounting designs
- Single-piece test switch and charge indicator
- Rated for damp location and enclosed & gasketed fixtures
- Galvanized steel construction
- RoHS compliant
- 5-Year Warranty

IOTA ISD Self-Diagnostics

IOTA ISD Series Emergency Ballasts provide automatic monthly and annual testing for both linear (ISD-80) or 4-pin compact (ISD-420) applications. In the event that the ISD unit encounters a fault, it will indicate the diagnosis via the dual-color indicator switch.



ISD-80

1100 LUMENS

Input Voltage

Universal 110-277VAC, 50/60Hz

Input Wattage

5 Watts (max)

Power Factor

≥ 0.9

Lamps Operated**

Most 2'-4' bipin T8 and T12 HO or VHO fluorescent lamps including long compact and 2'-4' 14W to 54W T5 lamps

Emergency Operation

(1) lamp - 90 minutes

Initial Illumination

(1) lamp up to 1100 lumens

Operating Temp

0° to 55° C

THD

< 20%

Battery

High-Temp Nickel-Cadmium
24 Hour Recharge
7-10 Year Life Expectancy

Weight

3.6 lbs

Approval

UL Listed for U.S. and Canada.
Rated for damp location, plenum, and enclosed & gasketed fixtures.

Dimensions

13.3" x 2.4" x 1.5"
(mounting center 12.75")

Self-Diagnostic Capability

LED Retrofit Solution

ISD-420-EM-A

1100 LUMENS

Input Voltage

Universal 110-277VAC, 50/60Hz

Input Wattage

5 Watts (max)

Power Factor

≥ 0.9

Lamps Operated

13W-57W 4-pin Rapid Start compact lamps including Twin, Triple, Quad Tube, 2D, and Straight

Emergency Operation

(1) lamp - 90 minutes

Initial Illumination

(1) lamp up to 1100 lumens

Operating Temp

0° to 55° C

THD

< 20%

Battery

High-Temp Nickel-Cadmium
24 Hour Recharge
7-10 Year Life Expectancy

Weight

5.6 lbs

Approval

UL Listed for U.S. and Canada.
Rated for damp location and plenum fixtures.

Dimensions

13.3" x 2.4" x 1.5"
(mounting center 12.75")

Self-Diagnostic Capability

LED Retrofit Solution

ISD-420-EM-B

1100 LUMENS

Input Voltage

Universal 110-277VAC, 50/60Hz

Input Wattage

5 Watts (max)

Power Factor

≥ 0.9

Lamps Operated

13W-57W 4-pin Rapid Start compact lamps including Twin, Triple, Quad Tube, 2D, and Straight

Emergency Operation

(1) lamp - 90 minutes

Initial Illumination

(1) lamp up to 1100 lumens

Operating Temp

0° to 55° C

THD

< 20%

Battery

High-Temp Nickel-Cadmium
24 Hour Recharge
7-10 Year Life Expectancy

Weight

3.6 lbs

Approval

UL Listed for U.S. and Canada.
Rated for damp location, plenum, and enclosed & gasketed fixtures.

Dimensions

13.3" x 2.4" x 1.5"
(mounting center 12.75")

Self-Diagnostic Capability

LED Retrofit Solution

FLUORESCENT & LED RETROFIT

**Not for use with single-pin lamps



LED Retrofit Solution

The AC Output design provides compatibility with many LED retrofit tube lamps as well as proper operation of environmentally-friendly low-mercury content amalgam fluorescents. See page 22 for LED compatibility details.



Self-Diagnostic Capability

The self-diagnostic function provides automatic monthly and annual testing of the emergency battery, charging system, and lamp to ensure proper operation and compliance with Life Safety requirements. Includes a single-piece dual-color LPTS test switch and charge indicator.



Cold Weather and Outdoor Egress

Designed to operate within **-18° to 50° C**, ICE Series Emergency Ballasts provide emergency lighting for outdoor paths of egress, such as covered walkways, parking garages, or exit points. The internal heating element and thermal control circuitry protect and maintain the battery in these harsher conditions.

ICE-80

1300 LUMENS

Input Voltage

Dual 120/277VAC, 60Hz

Input Wattage

3.5 Watts

Wattage Draw (with heating element on)

100 Watts

Lamps Operated

Most 2'-8' single, bipin T8 and T12 HO or VHO fluorescent lamps including long compact and 2'-4' 28W to 54W T5 lamps

Emergency Operation

(1) 2'-8' lamp or (2) 2'-4' lamp*

90 minutes *Long Compacts - 1 lamp only

Initial Illumination

(1) lamp up to 1300 lumens
(2) lamps up to 650 lumens each

Operating Temp

-18° to 50° C

Battery

High-Temp Nickel-Cadmium
24 Hour Recharge
7-10 Year Life Expectancy

Weight

3.6 lbs

Approval

UL Listed for U.S. and Canada.
Rated for damp location, plenum, and enclosed & gasketed fixtures.

Dimensions

13.3" x 2.4" x 1.5"
(mounting center 12.75")

Cold Weather and Outdoor Egress

ICE-420-EM-A

1300 LUMENS - DUAL FLEX

Input Voltage

Dual 120/277VAC, 60Hz

Input Wattage

3.5 Watts

Wattage Draw (with heating element on)

100 Watts

Lamps Operated

10W-70W 4-pin Rapid Start compact lamps including Twin, Triple, Quad Tube, 2D, and Straight

Emergency Operation

(1) 10W-70W or (2) 10W-32W

90 minutes

Initial Illumination

(1) lamp up to 1300 lumens
(2) lamps up to 650 lumens each

Operating Temp

-18° to 50° C

Battery

High-Temp Nickel-Cadmium
24 Hour Recharge
7-10 Year Life Expectancy

Weight

5.6 lbs

Approval

UL Listed for U.S. and Canada.
Rated for damp location and plenum fixtures.

Dimensions

13.3" x 2.4" x 1.5"
(mounting center 12.75")

Cold Weather and Outdoor Egress

ICE-420-EM-B

1300 LUMENS - NON-FLEX

Input Voltage

Dual 120/277VAC, 60Hz

Input Wattage

3.5 Watts

Wattage Draw (with heating element on)

100 Watts

Lamps Operated

10W-70W 4-pin Rapid Start compact lamps including Twin, Triple, Quad Tube, 2D, and Straight

Emergency Operation

(1) 10W-70W or (2) 10W-32W

90 minutes

Initial Illumination

(1) lamp up to 1300 lumens
(2) lamps up to 650 lumens each

Operating Temp

-18° to 50° C

Battery

High-Temp Nickel-Cadmium
24 Hour Recharge
7-10 Year Life Expectancy

Weight

3.6 lbs

Approval

UL Listed for U.S. and Canada.
Rated for damp location, plenum, and enclosed & gasketed fixtures.

Dimensions

13.3" x 2.4" x 1.5"
(mounting center 12.75")

Cold Weather and Outdoor Egress

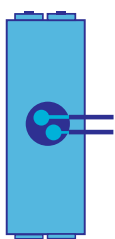

Thermal Heat Blanket

The internal battery of the ICE Series emergency ballast is encased within an electrically-controlled thermal blanket. The heating element of the blanket activates when conditions approach freezing temperatures. This protects the battery from being damaged by the extreme temperatures and ready to supply emergency illumination in the event of a power loss.

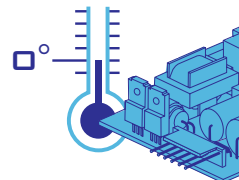

Temperature Control Circuitry

If the battery has been discharged for any reason, the Temperature Control Circuitry of the ICE emergency ballast ensures that the battery reaches acceptable temperatures before supplying a charge, preventing potential damage to the battery.



AVAILABLE
THIRD QUARTER

IOTA P-Series
IOTA's new "P-Series" fluorescent emergency ballasts feature a plug-in harness port for easily connecting and disconnecting the specialized wire assembly for simplified maintenance and upgrade.

P-32

500 LUMENS

Input Voltage
Universal 120-277VAC, 50/60Hz

Input Wattage
2.5 Watts

Lamps Operated
17W-32W 24"-48" T8, 32W U-bend T8 & 18W-40W 4-Pin Long Compact

Emergency Operation
(1) lamp
90 minutes

Initial Illumination
(1) lamp up to 500 lumens

Operating Temp
32° to 100° F

Battery
High-Temp Nickel-Cadmium
24 Hour Recharge
7-10 Year Life Expectancy

Weight
2.0 lbs

Approval
UL Listed for United States. Rated for damp location, plenum, and enclosed & gasketed fixtures.



Dimensions
9.5" x 2.25" x 1.25"
(mounting center 9.0")

P-40

700 LUMENS

Input Voltage
Universal 120-277VAC, 50/60Hz

Input Wattage
3.0 Watts

Lamps Operated
17W-32W 24"-48" T8, 32W U-bend T8, 32W-40W 48"-60" T8, & 18W-40W 4-Pin Long Compact

Emergency Operation
(1) lamp
90 minutes

Initial Illumination
(1) lamp up to 700 lumens

Operating Temp
32° to 100° F

Battery
High-Temp Nickel-Cadmium
24 Hour Recharge
7-10 Year Life Expectancy

Weight
2.0 lbs

Approval
UL Listed for United States. Rated for damp location, plenum, and enclosed & gasketed fixtures.



Dimensions
9.5" x 2.25" x 1.25"
(mounting center 9.0")

P-320

1350 LUMENS

Input Voltage
Universal 120-277VAC, 50/60Hz

Input Wattage
3.3 Watts

Lamps Operated
14W-28W 24"-48" T5, 25W-54W 24"-48" HO T5, 7W-32W 24"-48" T8, 32W-40W 48"-60" T8, 13W-26W 4-pin Quad, Twin Tube, 18W-42W 4-Pin Triple Tube, 18W-40W Long Compact

Emergency Operation
(1) lamp - 90 minutes

Initial Illumination
(1) lamp up to 700 lumens

Operating Temp
32° to 100° F

Battery
High-Temp Nickel-Cadmium
24 Hour Recharge
7-10 Year Life Expectancy

Weight
2.0 lbs

Approval
UL Listed for United States. Rated for damp location, plenum, and enclosed & gasketed fixtures.



Dimensions
13.25" x 2.25" x 1.25"
(mounting center 12.75")

Specialized Harness Plug and Port Design

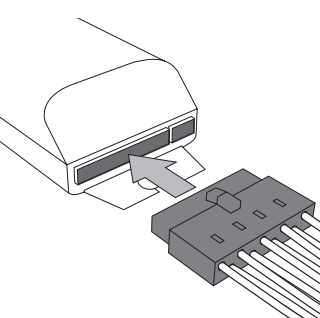

The specialized harness of the IOTA P-Series emergency ballasts allow for quick connecting and disconnecting of wiring to the lamps and AC ballast. Once wired, the harness securely snaps into the harness port of the P-Series ballast. The unit can then be easily removed and upgraded with other P-Series emergency ballasts as desired without the need for further wire connections. IOTA P-Series ballasts can also be used as direct replacements for Power Sentry PSQ500QD, PS600QD, and PS1400QD fluorescent emergency ballasts.

FLUORESCENT & LED RETROFIT

TSPL Test Switch and Indicator

The Plug-In Port of the IOTA P-Series also allows easy connection of the specialized TSPL test switch and indicator light.

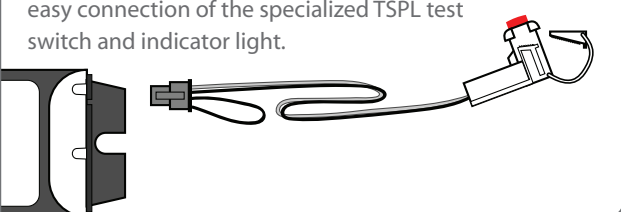
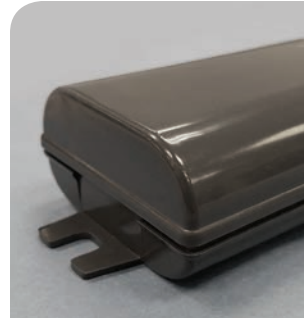
Lightweight, Durable Thermoplastic Design

IOTA P-Series features a durable and lightweight molded thermoplastic UL-94V-0 flame-rated enclosure designed for resistance against impact, scratches, and corrosion.

Mounting Configurations

IOTA emergency ballasts for compact lamps are available in a variety of mounting configurations to accommodate various fixture types and mounting scenarios. Refer to individual product specifications to determine which mounting options are available for each emergency ballast model.

DUAL FLEX CONFIGURATIONS

The **EM-A** provides dual flex for wiring to both the fixture or ballast compartment and test accessories.

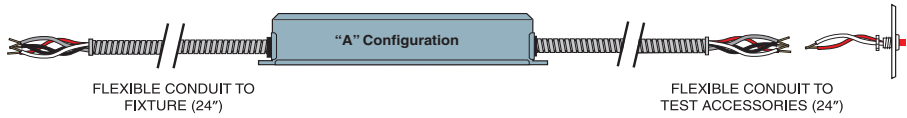

The **EM-R** provides dual flex for wiring to the fixture or ballast compartment. The single-piece test accessory is provided with hardware for installation directly within the reflector (recommended for OEM installation only).

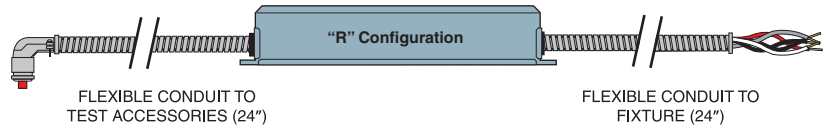

NON-FLEX CONFIGURATIONS

The **EM-B** allows for integral installation within the ballast compartment. The EM-B may also be mounted atop the fixture when used with a TMK-80 cover accessory.



The **EM-TM** provides a top-mounting option for running wires directly into the ballast compartment. Test accessories are then installed within the fixture.

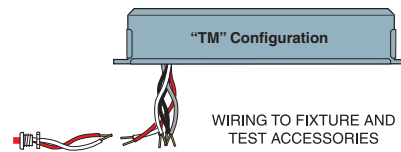

SINGLE FLEX CONFIGURATIONS

The **EM-J** is designed to be mounted to the junction box and provides flexible conduit for remote mounting of the test accessories.

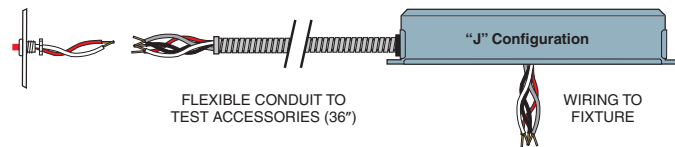

Like the EM-J, the **EM-R-J** can be mounted to the junction box. The single-piece test accessory is provided with hardware for installation directly within the reflector (recommended for OEM installation only).

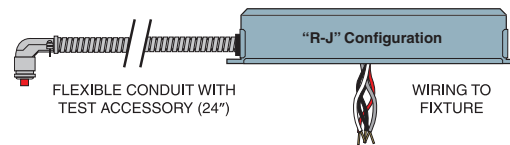

OPEN BOARD CONFIGURATIONS

Open Board emergency ballast kits include the circuit board with inverter and charger and separate battery pack. These kits are designed for installation within sconces, wall packs and other unusually shaped fixtures. The battery packs are available in three configurations to accommodate the available fixture space.

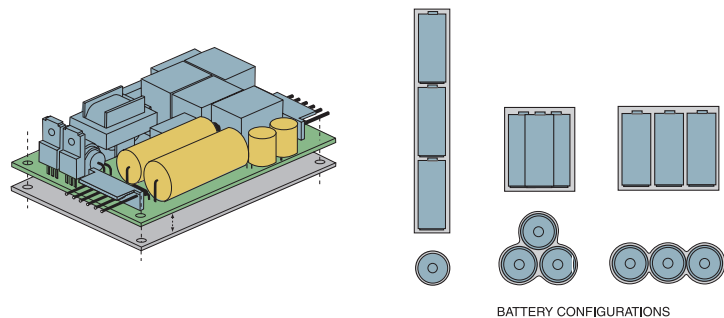

Responsible Design

IOTA Fluorescent Emergency Ballasts are designed and manufactured in compliance with adopted RoHS standards to minimize environmental impact of our electronic equipment through its complete life-cycle - from the initial production process to end-of-life recycling. The responsible design of the IOTA emergency ballasts restricts the presence of specified chemicals and substances by utilizing quality-driven and verified components that support both our commitment to the environment and life safety product performance.



Time Delay Enhancement

'End of Lamp Life' circuitry within normal AC ballasts is designed to allow the AC ballast to recognize when a fluorescent lamp is no longer operable. However, the End-of-Lamp-Life circuitry can mistakenly activate when power switches from an emergency battery pack to the AC supply. IOTA emergency battery packs provide a brief delay that allows the AC ballast to verify that the lamp is still functioning, eliminating conflicts with testing and operation of the emergency battery pack. Time Delay Enhancement is a standard design feature on all IOTA Series D and Series AC emergency ballasts.

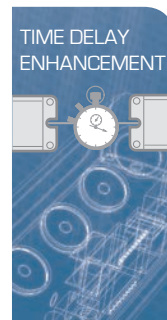

Open Circuit Isolation

It is not unusual for facility personnel to replace burnt-out fluorescent lamps while the fixture is still energized. When power is supplied to a fixture where no lamps are present, however, the resulting open circuit can cause damage to components in lesser-quality emergency ballasts within the fixture. IOTA emergency ballasts guard against the dangers of an open circuit caused when either the lamps are burned out or are being replaced. Open Circuit Isolation is a standard design feature on all IOTA Series D and Series AC emergency ballasts.

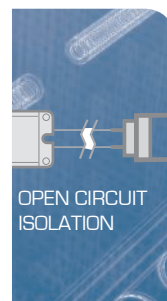

AC Output Performance

AC Series emergency ballasts from IOTA were the first emergency battery packs to offer compatibility with modern low-mercury content amalgam lamps. The advent of this lamp technology required a unique emergency ballast that could operate with the sensitive design of the lamp. IOTA's **AC Series** emergency ballasts were designed specifically to deliver emergency ballast compatibility with these environmentally-friendly lamps.

The innovative AC output design of the AC Series emergency ballasts also offers compatibility with certain LED tube lamp designs. Many IOTA AC Series ballasts have been tested and UL Listed as compatible emergency solutions for several manufacturer LED retrofit lamp designs. See Page 22-25 for details on LED lamp technology and compatible emergency ballast solutions.



FLUORESCENT & LED RETROFIT

Wiring Diagrams

Wiring of the emergency ballast will vary depending on the IOTA model, AC ballast, and lamp requirements. For wiring of a specific IOTA emergency ballast, call our Technical Services team at **1-855-363-9527** or find a full selection of wiring resources in our online Technical Library at www.iotaengineering.com/services.

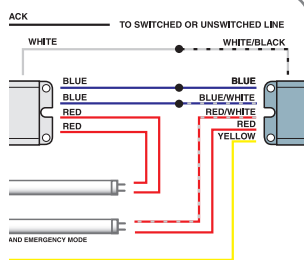

International Voltages



Select IOTA emergency ballasts are available in various international voltage standards of 220VAC and 240VAC input. For more information on IOTA emergency ballasts for international voltages, contact our Customer Service team.

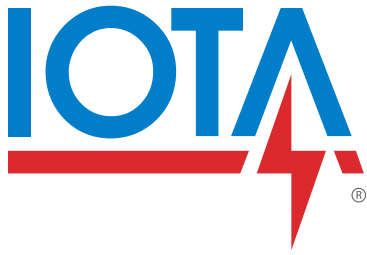

IIS Series Inverter Solutions



IOTA Inverter Systems offer powerful emergency egress solutions for virtually any type of lighting application. Deliver full emergency light output to multiple LED, fluorescent, and incandescent indoor or outdoor fixtures from one reliable auxiliary supply.

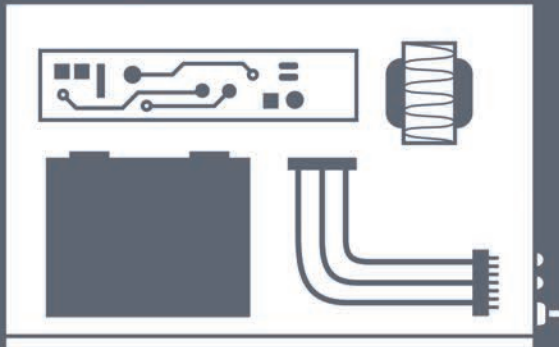

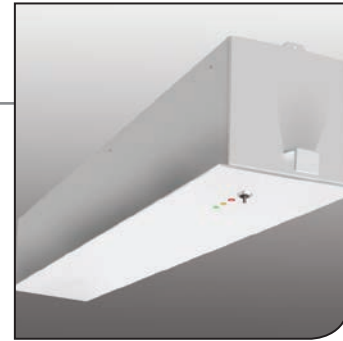

- **Mini and Micro Designs**

IOTA IIS Inverters include a full range of wattages to meet your individual load sizes, from 25 to 50 watt micro-inverters to 125 to 550 watt mini-inverter designs.

- **Reliable Solutions for your Lighting Technology**

The IIS Series operates lighting loads consisting of LED, fluorescent, and incandescent fixtures. Specialized models provide unique features to accommodate inrush requirements, CEC T20 performance, or dimming preferences.

- **Deliver Full Light Output**

IOTA inverters replicate normal AC line power during a power loss, operating the designated fixtures at full light output along your paths of egress just as they would during normal operation. The IIS inverters will bypass wall switch and dimming settings, ensuring your egress illumination is not compromised in an emergency situation.

- **Indoor and Outdoor Egress Possibilities**

The IIS Series can operate lighting loads at distances up to 250 to 1000 feet, allowing for indoor installation while operating bollards or walkway lighting along the building's outdoor paths of egress.



IIS Inverters combine IOTA's extensive emergency lighting experience with durable and reliable inverter system design. The IIS Series delivers maximum illumination for LED, fluorescent, and incandescent loads in demanding egress applications from one convenient supply...



Micro-Inverter Models

IOTA's IIS Micro-Inverters offer solutions for single fixture or smaller wattage applications. The units can be remotely mounted using available accessory options to provide 25, 35, or 50 watt emergency power to the designated fixture(s). IIS Micro-Inverters feature a replaceable nickel-cadmium battery and are covered under IOTA's 5-year warranty.



Mini-Inverter Models

IOTA IIS Mini-Inverters are designed to operate multiple fixtures from a single supply. Models range from 125 watts to 550 watts with design options to accommodate specific load criteria such as inrush potential, dimming requirements, and ceiling grid or surface mount preferences. IOTA IIS Mini-Inverters utilize a maintenance-free valve regulated lead acid (VRLA) battery and is covered under IOTA's 3/7 year pro-rata warranty.

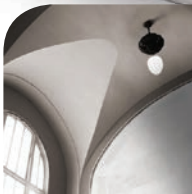

Elevated Ceilings

The full light output of the IIS Inverter is perfect for vaulted or high atrium ceilings in lobbies, foyers, and other critical points of egress.



Stairwells

The IIS Series can operate multiple fixtures in a building's stairwell and can bypass dimmers or occupancy sensors, keeping egress corridors lit without sacrificing your energy-saving controls.

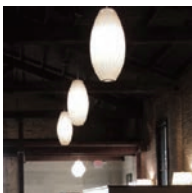

Decorative Fixtures

Hospitality and restaurants can utilize existing decorative LED or incandescent fixtures for emergency lighting, eliminating unattractive wall-mount fixtures in your designed space.



High Bay

High bay fixtures can take advantage of the full light output of IIS Inverters. A single IIS-550-I can operate up to ten 54W T5 lamps.

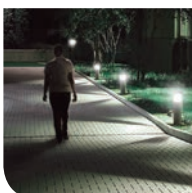

Outdoor Egress

The IIS Inverter installs within the building's interior, unaffected by exterior conditions. Illuminate walkways, steplights, or bollards along outdoor paths of egress up to 1000 feet away.



IIS-25-I

25-WATT MICRO-INVERTER

Input Voltage

Dual 120/277Vac, 60Hz

Input Rating (bulk)

32 Watts

Output Voltage

Slide Switch Selectable
120/277Vac, 60Hz

Output Power

25 Watts
(@0.9 leading to 0.9 lagging PF)

Lamps Operated

LED (per NEMA 410)
Fluorescent
Incandescent

Emergency Operation

90 minutes

Load Power Factor Range

0.9 leading to 0.9 lagging PF

Operating Temp

0° to 50° C

Battery

High-temp rechargeable,
replaceable nickel-cadmium

Weight

6.5 lbs

Approval

UL 924 Listed for U.S. and Canada.
CSA C22 No. 141 Unit Equipment
for Emergency Lighting.

UL LISTED

Damp Location Rated.
RoHS Compliant.

Dimensions

17.77" x 3.0" x 2.75"
(mounting center 17.25")

Qualified to NEMA 410

RoHS Compliant

IIS-35-I

35-WATT MICRO-INVERTER

Input Voltage

Dual 120/277Vac, 60Hz

Input Rating (bulk)

44 Watts

Output Voltage

Slide Switch Selectable
120/277Vac, 60Hz

Output Power

35 Watts
(@0.9 leading to 0.9 lagging PF)

Lamps Operated

LED (per NEMA 410)
Fluorescent
Incandescent

Emergency Operation

90 minutes

Load Power Factor Range

0.9 leading to 0.9 lagging PF

Operating Temp

0° to 50° C

Battery

High-temp rechargeable,
replaceable nickel-cadmium

Weight

6.5 lbs

Approval

UL 924 Listed for U.S. and Canada.
CSA C22 No. 141 Unit Equipment
for Emergency Lighting.

UL LISTED

Damp Location Rated.
RoHS Compliant.

Dimensions

17.77" x 3.0" x 2.75"
(mounting center 17.25")

Qualified to NEMA 410

RoHS Compliant

IIS-35-HE

35-WATT MICRO-INVERTER

Input Voltage

Universal 120-277Vac, 50/60Hz

Input Rating (bulk)

43 Watts

Output Voltage

Slide Switch Selectable
120/277Vac, 60Hz

Output Power

35 Watts
(@0.9 leading to 0.9 lagging PF)

Lamps Operated

LED (per NEMA 410)
Fluorescent
Incandescent

Emergency Operation

90 minutes

Load Power Factor Range

0.9 leading to 0.9 lagging PF

Operating Temp

0° to 50° C

Battery

High-temp rechargeable
nickel-cadmium

Weight

6.5 lbs

Approval

UL 924 Listed for U.S.

LISTED

California Title 20
Damp Location Rated.
RoHS Compliant.

Dimensions

19.94" x 2.88" x 2.75"
(mounting center 19.4")

Qualified to NEMA 410

RoHS Compliant

Certified CA Title 20

IIS-50-I

50-WATT MICRO-INVERTER

Input Voltage

Dual 120/277Vac, 60Hz

Input Rating (bulk)

60 Watts

Output Voltage

Slide Switch Selectable
120/277Vac, 60Hz

Output Power

50 Watts
(@0.9 leading to 0.9 lagging PF)

Lamps Operated

LED (per NEMA 410)
Fluorescent
Incandescent

Emergency Operation

90 minutes

Load Power Factor Range

0.9 leading to 0.9 lagging PF

Operating Temp

0° to 50° C

Battery

High-temp rechargeable,
replaceable nickel-cadmium

Weight

9.0 lbs

Approval

UL 924 Listed for U.S. and Canada.
CSA C22 No. 141 Unit Equipment
for Emergency Lighting.

UL LISTED

Damp Location Rated.
RoHS Compliant.

Dimensions

22.5" x 3.0" x 2.75"
(mounting center 22.0")

Qualified to NEMA 410

RoHS Compliant



5-Year Warranty



Qualified to NEMA 410

Qualified to NEMA 410 to handle increased inrush in LED load applications and provide confident operation with LED lighting system components.



RoHS Compliant

IOTA's IIS Micro-Inverters are responsibly designed and manufactured to RoHS standards for minimal environmental impact.



High-Efficiency Design

Features controlled power consumption to meet CEC energy requirements for the State of California.

Mini-Inverter Mounting

The 125W mini-inverter model is available in two mounting designs: Ceiling Grid (-CG) and Surface Mount (-SM). Larger wattage IIS units are available as surface mount models. See below for descriptions of the two mounting options.

Ceiling Grid Mounting

The ceiling grid model (IIS-125-CG) mounts across the 2-ft T-bars of a grid ceiling. Support wires are connected to the mounting tabs at the top of the unit and secured to the building framework. Knock-outs are located on one end of the unit for connecting conduit containing the AC supply and fixture leads. The 1.25-inch flange on either side provides support for the re-sized ceiling tile.

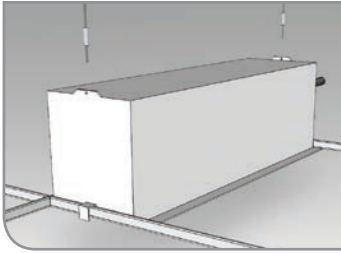

Surface Mounting

Surface mount models install directly to the wall. Keyhole slots at the back of the unit are spaced for secure mounting to the wall's unistrut or studs. Knockouts provide rear or side access for connection of wiring conduit. An additional hole is provided to prevent inadvertent lifting of the unit from the keyholes.

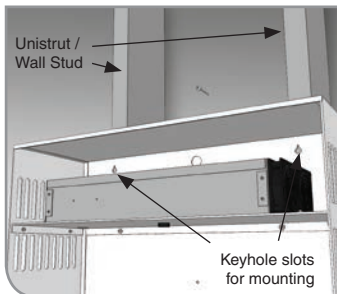

IIS-125-CG

125-WATT CEILING GRID MOUNT

Input Voltage

Dual 120/277Vac, 60Hz

Input Rating (bulk)

150 Watts

Output Voltage

Dual 120/277Vac, 60Hz

Output Power

125 Watts (@0.9 leading to 0.9 lagging PF)

Lamps Operated

LED*

Fluorescent

Incandescent

Transfer Time

< 50 milliseconds

Emergency Operation

90 minutes

Voltage Regulation (emergency)

+ / - 10%

Frequency Regulation (emergency)

+ / - 3%

Load Power Factor Range

0.9 leading to 0.9 lagging PF

Operating Temp

20° to 30° C

Battery

Maintenance-free valve-regulated lead-acid (VRLA)

Weight

42.5 lbs

Approval

UL 924 Listed for U.S.



Dimensions

23.75" x 6.50" x 7.625"

(incl. mounting brackets and flange: 23.375" x 8.0")

Dimming Relay Option

IIS-125-SM

125-WATT SURFACE MOUNT

Input Voltage

Dual 120/277Vac, 60Hz

Input Rating (bulk)

150 Watts

Output Voltage

Dual 120/277Vac, 60Hz

Output Power

125 Watts (@0.9 leading to 0.9 lagging PF)

Lamps Operated

LED*

Fluorescent

Incandescent

Transfer Time

< 50 milliseconds

Emergency Operation

90 minutes

Voltage Regulation (emergency)

+ / - 10%

Frequency Regulation (emergency)

+ / - 3%

Load Power Factor Range

0.9 leading to 0.9 lagging PF

Operating Temp

20° to 30° C

Battery

Maintenance-free valve-regulated lead-acid (VRLA)

Weight

46.0 lbs

Approval

UL 924 Listed for U.S.



Dimensions

23.15" x 11.71" x 4.5"

Dimming Relay Option

*IIS units not qualified to NEMA 410 require a 20% de-rating for LED applications

Designed for Superior Performance

IOTA IIS Mini-Inverters are engineered and manufactured for reliable performance in your egress applications...see Page 43 for more product details.

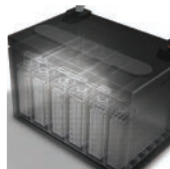

Long-Life VRLA Battery Supply



Low Battery Disconnect and Line Latch Protection



Durable Steel Construction with Powder Coat Finish



3/7 Pro-Rata Warranty



IIS-375-I

375-WATT MINI-INVERTER

Input Voltage

Dual 120/277Vac, 60Hz

Input Rating (bulk)

500 Watts

Output Voltage

Dual 120/277Vac, 60Hz

Output Power

375 Watts (@0.9 leading to 0.9 lagging PF)

Lamps Operated

LED*

Fluorescent

Incandescent

Transfer Time

< 50 milliseconds

Emergency Operation

90 minutes

Voltage Regulation (emergency)

+ / - 2% @ 15% to 110% load

Frequency Regulation (emergency)

+ / - 0.5%

Load Power Factor Range

0.9 leading to 0.9 lagging PF

Operating Temp

20° to 30° C

Battery

Maintenance-free valve-regulated lead-acid (VRLA)

Weight

114.0 lbs

Approval

UL 924 Listed for U.S.



Dimensions

23.0" x 17.83" x 8.2"

*IIS units not qualified to NEMA 410 require a 20% de-rating for LED applications



IIS-375-LED

375-WATT LED MINI-INVERTER

Input Voltage

Dual 120/277Vac, 60Hz

Input Rating (bulk)

500 Watts

Output Voltage

Dual 120/277Vac, 60Hz

Output Power

375 Watts (@0.9 leading to 0.9 lagging PF)

Lamps Operated

LED loads

per NEMA 410

Transfer Time

< 50 milliseconds

Emergency Operation

90 minutes

Voltage Regulation (emergency)

+ / - 2% @ 15% to 110% load

Frequency Regulation (emergency)

+ / - 0.5%

Load Power Factor Range

0.9 leading to 0.9 lagging PF

Operating Temp

20° to 30° C

Battery

Maintenance-free valve-regulated lead-acid (VRLA)

Weight

114.0 lbs

Approval

UL 924 Listed for U.S.



Dimensions

23.0" x 17.83" x 8.2"

Qualified to NEMA 410

Dimming Relay Option

DR DIMMING RELAY

The "DR" Dimming Relay option provides additional capability when used with dimming controls. The DR option interfaces with 0-10V leads to allow for the use of dimming settings without interfering with the emergency lighting function. See below for application details.

Dimmer Bypass Application

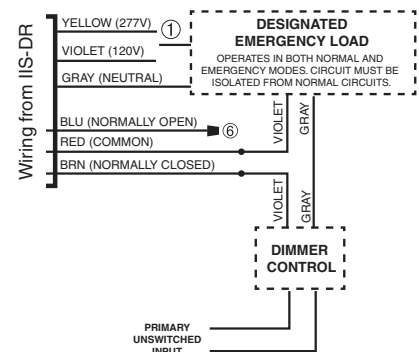

The Dimming Relay contacts provide electrical continuity during normal power conditions, allowing your dimming signal to operate the luminaire in the desired, dimmed state. When the inverter transfers into the emergency mode, the dimming relay contacts electrically open the 0-10 dimming reference signal and force the luminaire to operate at full lumen output regardless of the dimmer setting.

Add '-DR' to the IIS Model Number when requiring the Dimming Relay option.

IIS-125-CG	○	○ -DR
IIS-125-SM	○	
IIS-375-LED	○	
IIS-550-I	○	
IIS-550-HE (DR included)		



Qualified to NEMA 410

The IIS-375-LED Inverter is qualified to NEMA 410 to handle the accumulated inrush generated by multiple LED loads on the connected circuit. A NEMA 410 solution allows the inverter to operate a circuit at its full rated output without the need to de-rate the load size to accommodate the potential inrush. Learn more at www.iotaengineering.com/nema410



IIS-550-I

550-WATT MINI-INVERTER

Input Voltage

Dual 120/277Vac, 60Hz

Input Rating (bulk)

675 Watts

Output Voltage

Dual 120/277Vac, 60Hz

Output Power

550 Watts (@0.9 leading to 0.9 lagging PF)

Lamps Operated

LED*

Fluorescent

Incandescent

Transfer Time

< 50 milliseconds

Emergency Operation

90 minutes

Voltage Regulation (emergency)

+ / - 2% @ 15% to 110% load

Frequency Regulation (emergency)

+ / - 0.5%

Load Power Factor Range

0.9 leading to 0.9 lagging PF

Operating Temp

20° to 30° C

Battery

Maintenance-free valve-regulated lead-acid (VRLA)

Weight

145.0 lbs

Approval

UL 924 Listed for U.S.



Dimensions

23.0" x 17.83" x 8.2"

Dimming Relay Option



IIS-550-HE

550-WATT MINI-INVERTER

Input Voltage

Universal, 2-wire 120-277Vac, 60Hz

Input Rating (bulk)

750 Watts

Output Voltage

Auto-detect 120/277Vac, 60Hz

Output Power

550 Watts (@0.9 leading to 0.9 lagging PF)

Lamps Operated

LED (per NEMA 410)

Fluorescent

Incandescent

Transfer Time

< 1 second

Emergency Operation

90 minutes

Surge Protection

Meets ANSI/IEEE C62.41.2-2002

Frequency Regulation (emergency)

+ / - 1 Hz (< 2%)

Load Power Factor Range

0.9 leading to 0.9 lagging PF

Operating Temp

20° to 30° C

Battery

Maintenance-free valve-regulated lead-acid (VRLA)

Weight

163.0 lbs

Approval

UL 924 Listed for U.S.



California Title 20



Dimensions

22.0" x 19.75" x 11"

Qualified to NEMA 410

Certified CA Title 20

Dimming Relay Included

DR DIMMING RELAY

The "DR" Dimming Relay option provides additional capability when used with dimming controls. The DR option interfaces with 0-10V leads to allow for the use of dimming settings without interfering with the emergency lighting function. See below for application details.

Dimmer Bypass Application

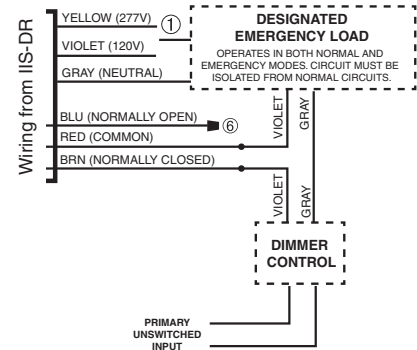

The Dimming Relay contacts provide electrical continuity during normal power conditions, allowing your dimming signal to operate the luminaire in the desired, dimmed state. When the inverter transfers into the emergency mode, the dimming relay contacts electrically open the 0-10V dimming reference signal and force the luminaire to operate at full lumen output regardless of the dimmer setting.

Add '-DR' to the IIS Model Number when requiring the Dimming Relay option.

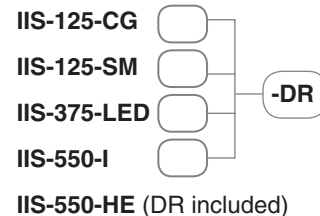

Remote Mounting Distances

The distance at which the IIS Inverter will operate a load is determined by a combination of the voltage, load wattage, and wire gauge. This table will help determine the maximum remote mounting distance (in feet), allowing for a 3% voltage drop.

Watts	120V			277V
	14 gauge	12 gauge	10 gauge	14 gauge
50W	1600 ft	2468 ft	4084 ft	8623 ft
100W	809 ft	1249 ft	2066 ft	4311 ft
125W	646 ft	997 ft	1649 ft	3445 ft
150W	537 ft	829 ft	1372 ft	2874 ft
200W	404 ft	624 ft	1033 ft	2155 ft
250W	323 ft	493 ft	827 ft	1722 ft
300W	268 ft	414 ft	686 ft	1437 ft
350W	230 ft	356 ft	589 ft	1230 ft
375W	214 ft	331 ft	548 ft	1146 ft
550W	146 ft	226 ft	374 ft	779 ft

Extended Run-times

Emergency lighting for Tornado Safe Rooms require a two hour minimum of emergency operation to meet FEMA requirements. While IOTA IIS Inverters are typically used for 90-minute run-times per the Life Safety Code, they can fulfill the FEMA requirement by balancing the load demand with the battery capacity. Refer to the chart on the right for sizing the IIS load to achieve two hour operation.

For more information regarding IOTA products for FEMA applications, contact our Customer Service team or visit the FEMA website at www.fema.gov.

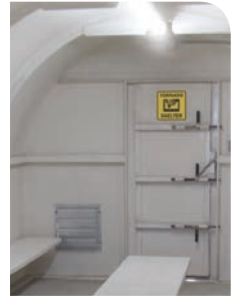

Model	De-rating
IIS-25	20W
IIS-35	26W
IIS-50	40W
IIS-125	100W
IIS-375	300W
IIS-550	440W

Typical Wiring Diagram - Mini-Inverter

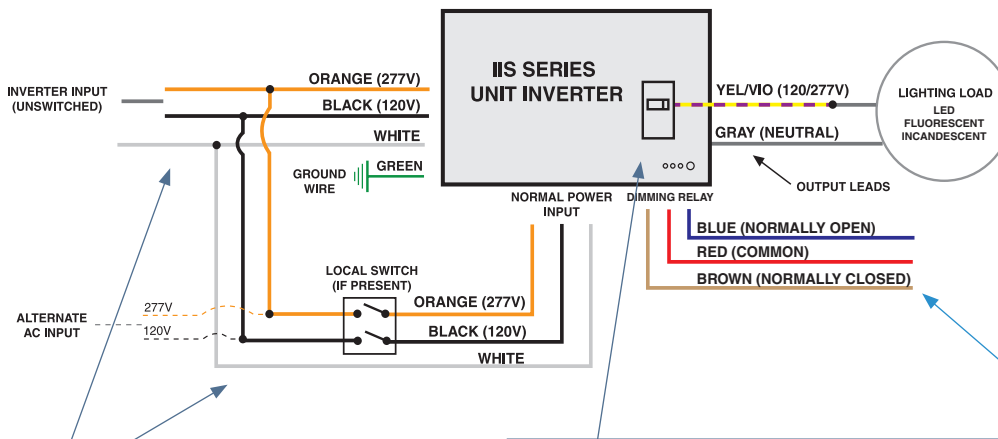

Wiring of the IIS Inverter may vary depending on the specific model. Always refer to the product specification sheet or installation manual for specific wiring details. Find a full selection of IIS Inverter resources in our online Technical Library at www.iotaengineering.com/services or call our Technical Services team at 1-855-363-9527.

AC Input Leads

IIS Inverters utilize two sets of input leads: one to provide unswitched power to the inverter system and a second to serve as a normal power input to the lighting circuit. Any switch for the designated load will be present on the Normal Power Input leads. For emergency operation only, the Normal Input leads would be disconnected and capped.

Internal Circuit Breaker

The internal circuit breaker protects the inverter from overload on the output side of the unit. Internally, the appropriate voltage lead is selected for connection to the line side of the circuit breaker and the designated emergency load connects to the single Yellow/Violet 120/277V hot lead. *Note: circuit breaker wiring may vary depending on model.*

Dimming Relay (optional)

Dimming Relay options are available on select models for accommodating energy-saving control settings. See the **DR Dimming Relay** section on the preceding page for details.

Typical Wiring Diagram - Micro-Inverter

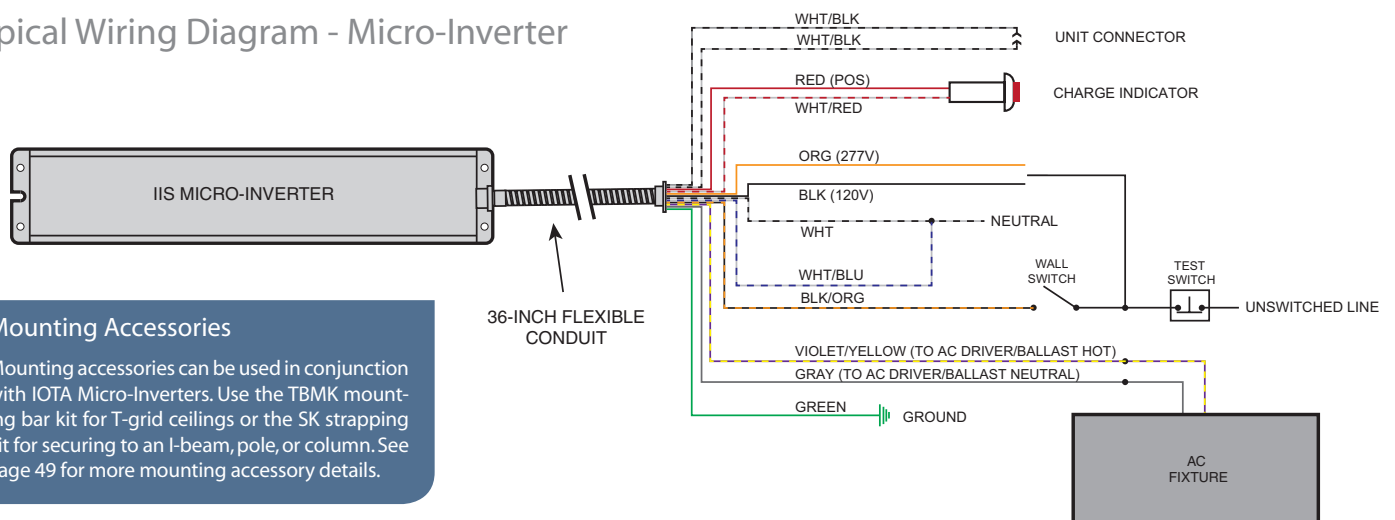

Mounting Accessories

Mounting accessories can be used in conjunction with IOTA Micro-Inverters. Use the TBMK mounting bar kit for T-grid ceilings or the SK strapping kit for securing to an I-beam, pole, or column. See Page 49 for more mounting accessory details.

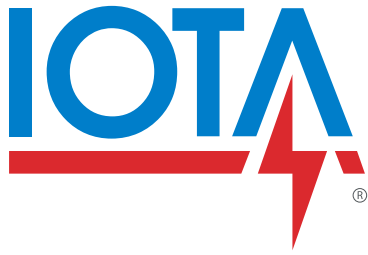

Auxiliary Control Devices and Installation Accessories

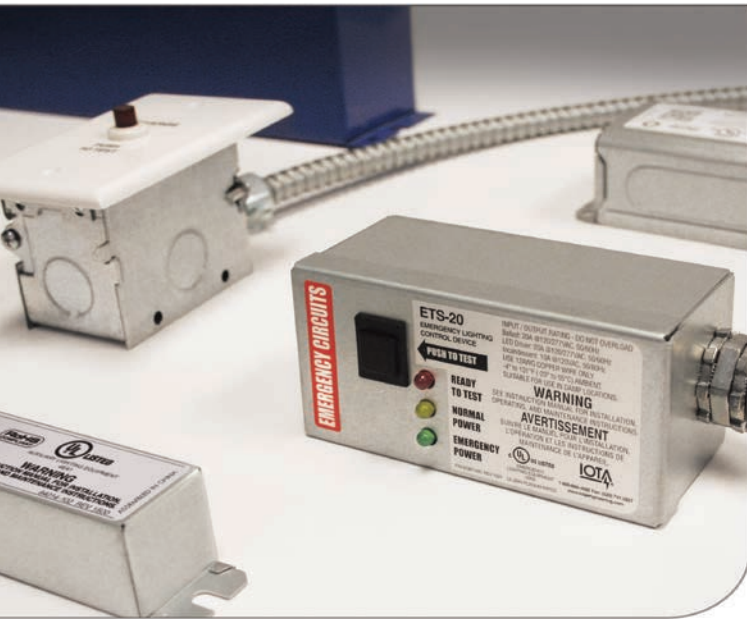

IOTA's emergency control devices and mounting accessories work in conjunction with your emergency lighting and auxiliary supplies to deliver improved energy savings, enhanced lighting control, or ease of installation and access.



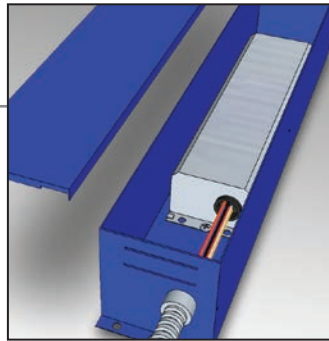

- **Energy-Saving Controls for Emergency Lighting**

IOTA ETS-DR and ETS-20 products eliminate the need for energy-wasting night lights and always-on fixtures by allowing the use of switches and controls on auxiliary generator and inverter circuits.

- **Dimming Relays**

Use ETS "DR" and ETS-STEP models to bring enhanced 0-10V dimming control for operating fixtures at your preferred lighting level. During a loss of normal power, the IOTA ETS device will allow operation of the fixture at full brightness from the auxiliary supply.

- **Dual Zone Dimming**

IOTA's innovative ETS-20-DR provides enhanced dimming control on emergency fixtures with Dual Zone Dimming capability, bypassing up to two different dimming control settings during a loss of normal power.

- **Mounting Accessories**

Our mounting accessories offer convenient solutions to make your IOTA emergency battery pack or micro-inverter a perfect fit for your fixture or facility application.



Energy Savings and Enhanced Control

IOTA's ETS-20 and ETS-20-DR allow you to regain the use of switching or other controls, such as dimmers, timers, or occupancy sensors, on your designated emergency fixtures powered by an auxiliary AC supply. In the event of a power loss, the ETS unit will bypass the local control device to allow emergency power to the fixture. This promotes increased energy savings by eliminating the need for unswitched or "always-on" night lights in your facility.

ETS-20

FOR 20-AMP LOADS

Input Voltage

Dual 120/277VAC, 50/60Hz

Maximum Load Ratings

LED Driver: 8A @ 120Vac, 50/60Hz per NEMA 410

LED Driver: 8A @ 277Vac 50/60Hz per NEMA 410

Ballast: 20A @ 120/277Vac, 50/60Hz

Incandescent: 10A @ 120Vac, 50/60Hz

Emergency Operation

The ETS-20 will operate in conjunction with any lighting load as noted in the specifications in the designated 20 amp circuit for the duration of the auxiliary supply.

Initial Illumination

Full light output

Operating Temp

-20° to 55° C (-4° to 131° F)

Weight

1.0 lbs

Approval

UL 924 Listed.

Rated for damp location and plenum applications.

Dimensions

4.625" x 2.25" x 2.25"

Threaded Coupling: 1" with 0.5 diam.

Qualified to NEMA 410

Typical Application

During presence of normal power, the ETS-20 senses the setting of the 'ON/OFF' control device through the red wire (Control Device Sensor) and operates the Normal/EM mode accordingly. When normal power is lost, the ETS-20 allows operation of the Normal/EM load at full output from the auxiliary supply, regardless of control device status.

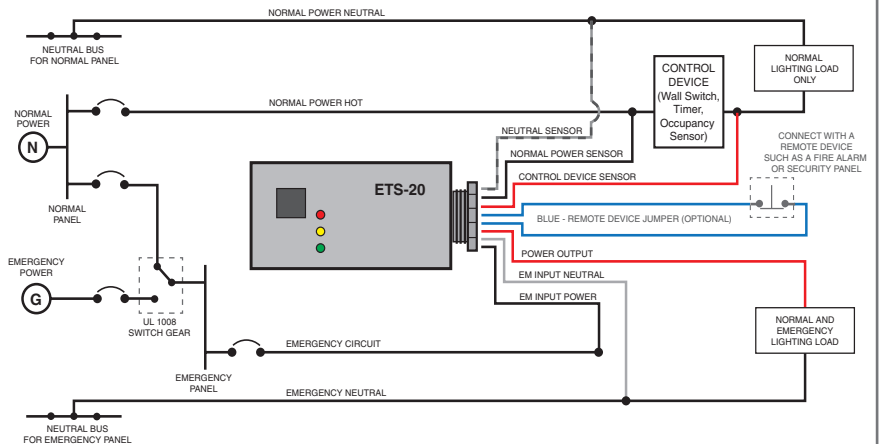

Dimming Option Application

The ETS-20 can also be used with dimming applications by applying a second dimmer to the Normal/EM circuit. This 'two dimmer' arrangement provides dimming capabilities to the Normal and Normal/EM loads separately. In this scenario, when emergency power is activated, the ETS-20 will then route power around only the dimmer on the EM circuit. For more enhance dimming functionality, see the ETS-20-DR.

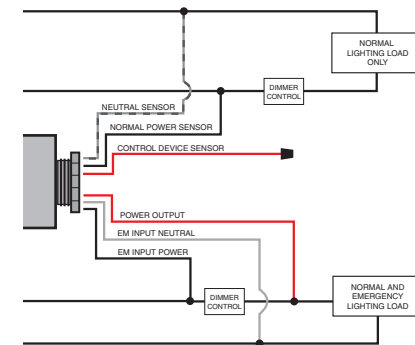

Designed for Superior Performance

IOTA Emergency Lighting Products are engineered and manufactured for reliable performance in your egress applications.

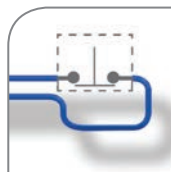

Jumper lead for connection to optional trigger device.



Galvanized steel construction



Suitable for damp, freezing, or plenum applications



RoHS-Compliant



5-Year Warranty

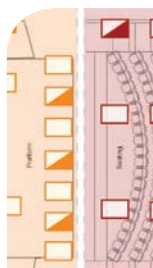

Dual Zone Dimming with the ETS-20-DR

The ETS-20-DR provides two sets of dimming relays for use with Dual Zone dimming (such as a classroom that would demand full brightness on the speaker and a dimmed zone over the audience). The ETS-20-DR allows for two-wire dimming of zones that would be comprised of both normal and EM fixtures. In the event of a power loss, any dimmed emergency fixtures in either zone will switch to the emergency supply and come on at full brightness.

ETS-20-DR

20-AMP WITH DIMMING RELAY

Input Voltage

Dual 120/277VAC, 50/60Hz

Maximum Load Ratings

LED Driver: 8A @ 120Vac, 50/60Hz per NEMA 410

LED Driver: 8A @ 277Vac 50/60Hz per NEMA 410

Ballast: 20A @ 120/277Vac, 50/60Hz

Incandescent: 10A @ 120Vac, 50/60Hz

Emergency Operation

The ETS-20-DR will operate in conjunction with any lighting load as noted in the specifications in the designated 20 amp circuit for the duration of the auxiliary supply.

Initial Illumination

Full light output

Operating Temp

-20° to 55° C (-4° to 131° F)

Weight

1.0 lbs

Approval

UL 924 Listed.

Rated for damp location and plenum applications.

Dimensions

4.625" x 2.25" x 2.25"

Threaded Coupling: 1" with 0.5 diam.

Qualified to NEMA 410

Dimming Relay Option

Typical Application

Function and wiring of the ETS-20-DR is identical to that of the ETS-20 but with the addition of the Dimming Relay leads. The red wire serves as the 'switch sense' for the master switch position for all zones, allowing all of the emergency fixtures to be switched off or dimmed when not needed.

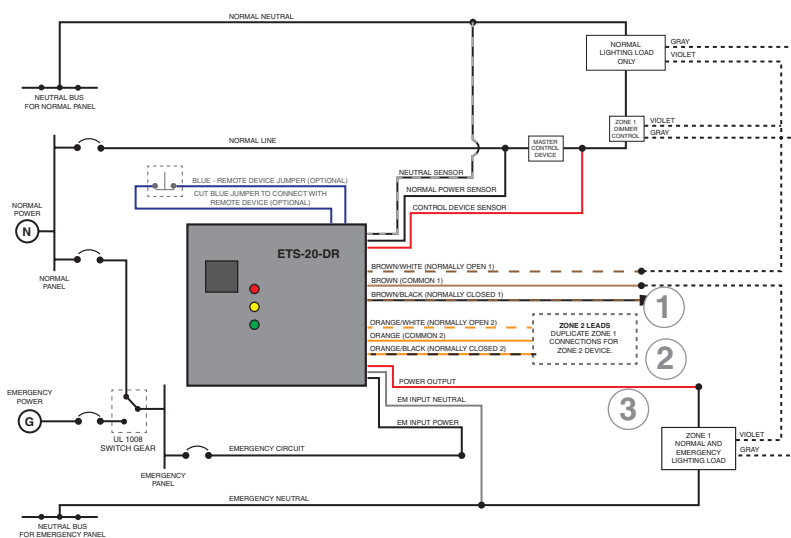

Connecting the Dimming Relays

- 1 The first relay leads connect to the dimming control for Zone 1. The dimming signal is passed through the ETS-20-DR to the EM load. During a power loss, the dimming signal is bypassed and full power is given to the EM load.
- 2 For this application, the unused relay lead is capped. However, this lead can be connected to another control device (such as an alternative dimmer) to accept a signal other than full output while in the EM mode.
- 3 Duplicate the connections for the second set of relays to Zone 2.

CONTROLS & ACCESSORIES



Qualified to NEMA 410

IOTA ETS products are qualified to NEMA 410 to handle increased inrush in LED load applications and provide confident operation with LED lighting system components.



Dimming Relays

The ETS-20-DR features two sets of dimming relays that enable users to bypass two separate dimming controls, providing dimming in up to two different zones without compromising emergency lighting.

Learn more on YouTube...

Our YouTube video provides helpful insight into operation and installation of the ETS-20 and ETS-20-DR control unit.



SCAN TO WATCH



ETS-DR

EMERGENCY CONTROL DEVICE WITH 0-10V DIMMING RELAY

The IOTA ETS-DR allows the use of local controls, such as a wall switch, timer, or occupancy sensor, on a designated emergency fixture powered by an auxiliary power supply. In the event of a power loss, the ETS-DR will bypass the local control to allow power from the auxiliary supply. This promotes increased energy savings by eliminating the need for unswitched or “always-on” night lights in your facility. The ETS-DR includes 0-10V dimming relay leads to allow fixtures to operate normally at the preferred illumination level but will bypass those settings to operate the emergency fixture at full output while in emergency mode.

Input Voltage

Dual 120/277Vac, 60Hz

Input Current

35 mA

Maximum Switching Voltage

3 Amps @ 120Vac

3 Amps @ 277Vac

Circuit Protection

3A on Control Input

3A on Neutral and 120/277V Outputs

Dimming Capability

For use in 0-10 volt dimming circuits

up to 100mA

Emergency Operation

The ETS-DR allows operation of any lamp type in the designated fixture for the duration of the auxiliary supply.

Initial Illumination

Full light output

Operating Temp

0° to 55° C

Weight

1.0 lbs

Approval

UL 924 Listed for U.S.



Rated for use in plenum fixtures.

Dimensions

8.0" x 1.18" x 1.125"

(mounting center: 7.5")

Qualified to NEMA 410

0-10Vdc Dimming Relays



ETS-STEP

EMERGENCY CONTROL DEVICE FOR STEP DIMMING

The IOTA ETS-STEP utilizes a dual relay design to accommodate bi-level controls for step dimming applications. The ETS-STEP allows the fixture to be controlled at the different switched states during normal power but will bypass those settings to operate the fixture at full output while in emergency mode.

Input Voltage

Dual 120/277Vac, 60Hz

Input Current

35 mA

Maximum Switching Voltage

3 Amps @ 120Vac

3 Amps @ 277Vac

Circuit Protection

3A on Control Input

3A on 120/277V Outputs

Dimming Capability

For use in step dimming applications

Emergency Operation

The ETS-STEP allows operation of any lamp type in the designated fixture for the duration of the auxiliary supply.

Initial Illumination

Full light output

Operating Temp

0° to 55° C

Weight

1.0 lbs

Approval

UL 924 Listed for U.S.



Rated for use in plenum fixtures.

Dimensions

8.0" x 1.18" x 1.125"

(mounting center: 7.5")

Qualified to NEMA 410

Step Dimming Relays



Qualified to NEMA 410

IOTA ETS models are qualified to NEMA 410 to handle increased inrush in LED load applications and provide confident operation with LED lighting system components.



Galvanized steel construction

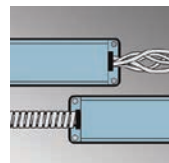

Integral and Flex Models Available



RoHS-Compliant

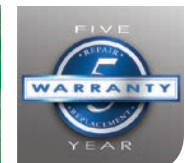

5-Year Warranty

IOTA mounting accessories provide options for remote installation of the emergency ballast and test equipment and for ensuring compliance with national and local code requirements. For further details on IOTA mounting accessories, contact our Customer Service team.

TMK-80, TMK-32 and TMK-ISL Top Mount Cover

Use the **TMK** accessory when a unit is mounted on top of the fixture. To avoid exposed wiring when emergency battery packs are top-mounted, the **TMK** is used to cover the wiring that goes from the battery pack into the fixture. **TMK** models are available for standard profile (TMK-80), reduced profile (TMK-32), and slim or low profile (TMK-ISL) units.

Can be used with [IOTA EMERGENCY LED DRIVERS](#) [IOTA EMERGENCY BALLASTS](#)

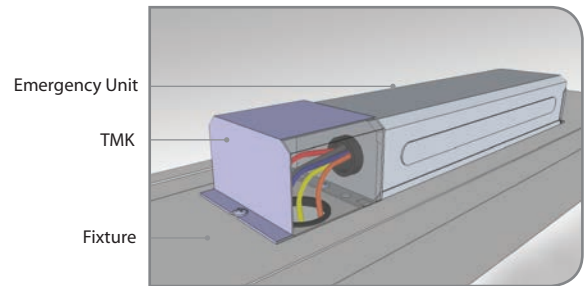

TBMK Mounting Kit

Use the **TBMK** in instances where the battery pack cannot be mounted on the fixture, such as with downlights or other compact T-grid applications. The battery pack is mounted on the **TBMK**, which is then mounted on the T-bars of the ceiling grid. The battery pack is secured to the **TBMK** with mounting clips. Wiring runs to the fixture via flexible conduit. The **TBMK** can accept any size IOTA emergency battery pack, and can also be used in conjunction with the RME1 remote mounting enclosure.

Can be used with [IOTA EMERGENCY LED DRIVERS](#) [IOTA EMERGENCY BALLASTS](#) [IOTA IIS MICRO-INVERTERS](#)

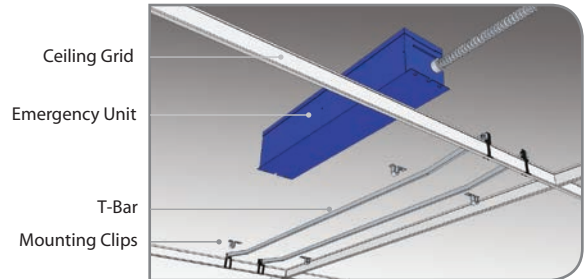

RTK Remote Test Kit

The Remote Test Kit (RTK) allows for remote mounting of the test switch and charge indicator light. The kit consists of 3 feet of flex, the junction box containing the test switch and charge indicator, and faceplate. Also available with single-piece TBTS test accessory (TBTS-RTK). When ordering, specify which IOTA models are being equipped with RTK accessories to ensure component compatibility. (Not available for units utilizing TSPL components.)

Can be used with [IOTA EMERGENCY LED DRIVERS](#) [IOTA EMERGENCY BALLASTS](#)

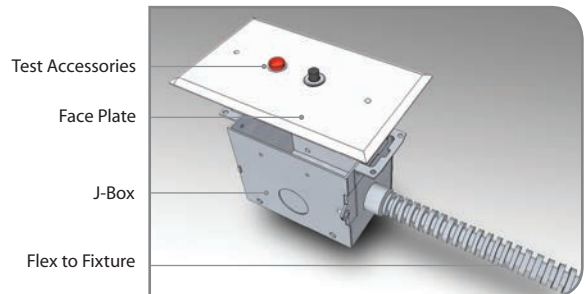

RME1 Remote Mounting Enclosure

The **RME1** enclosure is the perfect size to accept most IOTA non-flexed battery packs for remote mounting. The emergency battery pack is secured within the enclosure and wiring is routed through the 2-ft flexible conduit of the **RME1** to the fixture.

Enclosure Dimensions: 16.375" x 3.0" x 3.0"

Can be used with [IOTA EMERGENCY LED DRIVERS](#) [IOTA EMERGENCY BALLASTS](#)

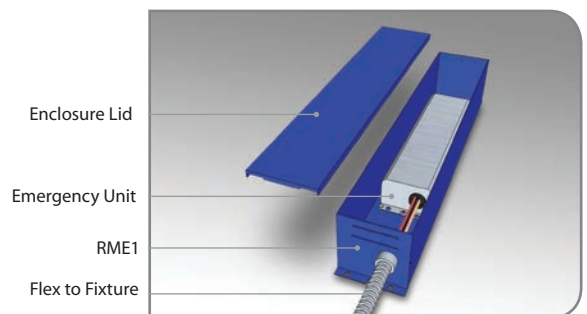

SK Strapping Kit

The strapping kit provides (2) straps that run through the mounting tabs on select IOTA units for securing to a beam or column near the fixture. Overall strap length is 18".

Can be used with [IOTA EMERGENCY LED DRIVERS](#) [IOTA IIS MICRO-INVERTERS](#)

